

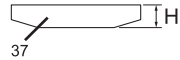

**CP3239-GABSYGE / CP3249-GABSYGE /
CP3249-GABSUDE / CP3239-GABSYLE**

Part no : 6159945140
Issue no : 02
Seris no : C
Date 03/2012
Page : 1 / 5

	CP324. (mm)	CP323. (mm)
H maxi	23	19.9
H mini	21	17.9

	Governor spring / Ressort de régulateur Muelle de regulador / Feder des Reglers				
CP3249-GABSUDE	4 500 rpm	Violet	Purple	Violeta	Veilchenblau
CP3239-GABSYGE/ CP3249-GABSYGE/ CP3239-GABSYLE	6 000 rpm	Orange	Orange	Naranja	Orange

WARNING
Do not operate
without wheel Guard

WARNING
TO REDUCE INHALEABLE QUANT OF SPRING DUST,
SEAL AND DISCHARGE SPRINGLY PROVED
SAFELY INSTRUCTIONS.

WARNING
RPM RATING ON WHEEL
MUST EXCEED
GRINDER RPM RATING

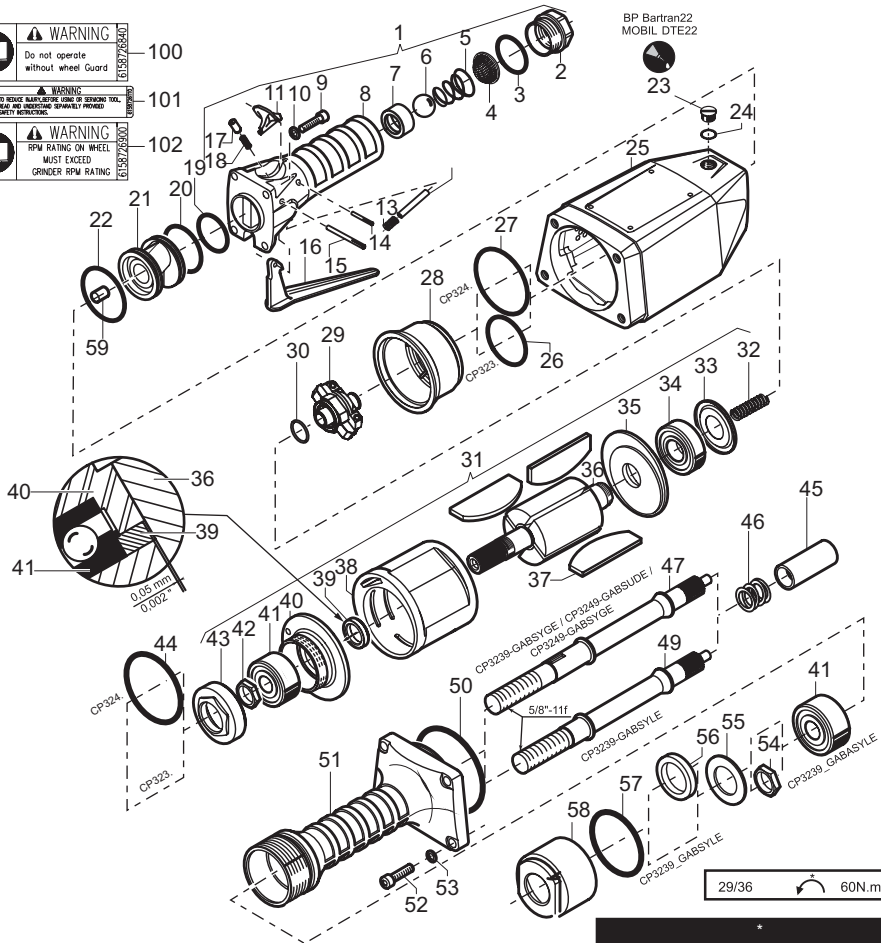

29/36  60N.m

	CP3239-GABSYGE/ CP3239-GABSYLE	CP3249-GABSYGE	CP3249-GABSUDE
rpm	6 000	6 000	4 500
W (hp)	2 000 (2.7)	2 700 (3.62)	2 400 (3.22)

Tightening direction	Kiristyssuunta
Sens de serrage	Atdragningsriktning
Sentido de apriete	Tilstrammingsretning
Anziehrichtung	Tilspændingsretning
Senso di serraggio	Schroëfrichtung
Sentido de aperto	Φορδ άσύριξης

Part no : 6159945140
 Issue no : 02
 Seris no : C
 Date 03/2012
 Page : 2 / 5

**CP3239-GABSYGE / CP3249-GABSYGE /
 CP3249-GABSUDE / CP3239-GABSYLE**

Item Rep	New part no Réf. standard	Qty Qté	Specifics parts Pièces spécifiques	Description	Désignation
1	395.61	1		Throttle handle compl.	Robinet complet
2	730.132	1		Adapter	Bague de raccordement
3	6156581150	1		O ring	Joint torique
4	744.08	1		Strainer	Tamis
5	6156810200	1		Spring	Ressort
6	6157700190	1		Ball	Bille
7	6153210800	1		Seat	Siège de bille
8	315.30	1		Throttle handle	Corps de robinet
9	616.99	4		Screw	Vis
10	645.35	4		Washer	Rondelle
11	6153210820	1		Latch lever	Verrou
12	790.12	1		Pin	Aiguille
13	6156810190	1		Spring	Ressort
14	638.06	1		Roll pin	Goupille
15	6156380050	1		Roll pin	Goupille
16	6153210830	1		Lever	Levier
17	321.81	1		Cover	Coiffe
18	681.18	1		Spring	Ressort
19	658.107	1		O ring	Joint torique
20	658.112	1		O ring	Joint torique
21	321.72	1		Oil tank	Réservoir d'huile
22	658.130	1		O ring	Joint torique
23	614.02	1		Screw	Vis
24	650.16	1		O ring	Joint
25	6153962770	1	CP323.	Motor Housing	Carter Turbine
25	6153962780	1	CP324.	Motor Housing	Carter Turbine
26	658.117	1	CP323.	O ring	Joint torique
27	658.118	1	CP324.	O ring	Joint torique
28	6153211830	1	CP324.	Governor housing	Boîtier de régulation
28	321.94	1	CP323.	Governor housing	Boîtier de régulation
29	457.18	1		Governor	Régulateur
30	658.120	1		O ring	Joint torique
31	394.26	1	CP323.	Complete motor	Moteur monté
31	394.54	1	CP324.	Complete motor	Moteur monté
32	6156811030	1	CP3249-GABSUDE CP3239-GABSYGE/ CP3249-GABSYGE CP3239-GABSYLE	Spring of governor	Ressort de régulateur
32	6156811040	1		Spring of governor	Ressort de régulateur
33	557.93	1		Flange	Flasque
34	758.17	1		Ball bearing	Roulement
35	422.121	1	CP323.	Rear plate-end	Joue AR

**CP3239-GABSYGE / CP3249-GABSYGE /
CP3249-GABSUDE / CP3239-GABSYLE**

Part no : 6159945140
Issue no : 02
Seris no : C
Date 03/2012
Page : 3 / 5

Item Rep	New part no Réf. standard	Qty Qté	Specifics parts Pièces spécifiques	Description	Désignation
35	422.129	1	CP324.	Rear plate-end	<i>Joue AR</i>
36	426.46	1	CP323.	Rotor	<i>Rotor</i>
36	426.68	1	CP324.	Rotor	<i>Rotor</i>
37	434.42	3	CP323.	Blade	<i>Palette</i>
37	434.48	3	CP324.	Blade	<i>Palette</i>
38	400.110	1	CP323.	Liner	<i>Cylindre</i>
38	400.120	1	CP324.	Liner	<i>Cylindre</i>
39	661.75	1		Ring	<i>Bague de joue</i>
40	420.119	1	CP324.	Front plate-end	<i>Joue AV</i>
40	420.114	1	CP323.	Front plate-end	<i>Joue AV</i>
41	754.17	2		Ball bearing	<i>Roulement</i>
42	607.49	1		Nut	<i>Ecrou</i>
43	673.68	1		Plug	<i>Bouchon</i>
44	657.32	1	CP324.	O ring	<i>Joint torique</i>
45	575.84	1		Coupling sleeve	<i>Manchon d'accouplement</i>
46	680.99	1		Spring	<i>Ressort</i>
48	501.36	1	CP3239-GABSYGE/ CP3249-GABSYGE/ CP3249-GABSUDE	Shaft	<i>Arbre porte-meule</i>
49	6155010970	1	CP3239-GABSYLE	Shaft	<i>Arbre porte-meule</i>
50	658.116	1	CP324.	O ring	<i>Joint torique</i>
50	658.118	1	CP323.	O ring	<i>Joint torique</i>
51	552.18	1	CP323.	Handle	<i>Poignée AV</i>
51	552.19	1	CP324.	Handle	<i>Poignée AV</i>
52	223133	4		Screw	<i>Vis</i>
53	640.06	4		Washer	<i>Rondelle</i>
54	607.49	1	CP3239-GABSYLE	Nut	<i>Ecrou</i>
55	643.54	1		Washer	<i>Rondelle</i>
56	654.05	1	CP3239-GABSYGE/ CP3249-GABSYGE/ CP3249-GABSUDE/ CP3239-GABSYLE	Felt	<i>Feutre</i>
57	658.113	1		O ring	<i>Joint torique</i>
58	673.69	1		Plug	<i>Bouchon AV fileté</i>
58	673.70	1		Plug	<i>Bouchon AV fileté</i>
59	675.06	1		Oiler	<i>Graisneur</i>
100	6158726840	1		Warning guard label	<i>Etiquette protecteur</i>
101	6158726110	1		Warning instruction	<i>Etiquette instructions</i>
102	6158726900	1		Warning wheel speed label	<i>Etiquette vitesse meuleuse</i>

Part no : 6159945140
 Issue no : 02
 Seris no : C
 Date 03/2012
 Page : 4 / 5

**CP3239-GABSYGE / CP3249-GABSYGE /
 CP3249-GABSUDE / CP3239-GABSYLE**

**Accessories included
 Mitgeliefertes Zubehör
 Varusteet
 Leveret tilbehør**

**Accessoires livrés
 Accessori forniti
 Levererade tillbehör
 Geleverde accessoires**

**Accesorios suministrados
 Acessórios fornecidos
 Tilbehør som følger med
 Παρεχόμενα εξαρτήματα**



Item Rep	New part no. Réf. standard	Qty Qté	Description	Désignation
60	6157040140	1	1/2" air hose nipple for 5/8" ID hose	Busette 1/2" pour tuyau Ø int. 15 mm

Ø 165 x 30 x 15,9 (6-5/8" x 1-3/16" x 5/8") Flap wheel assembly / Montage roue à lamelles

**CP3239-GABSYGE/
 CP3249-GABSYGE**

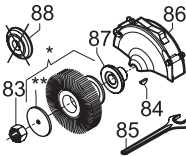

Item Rep	New part no. Réf. standard	Qty Qté	Description	Désignation
83	615 608006 0	1	Nut	Écrou
84	615 630019 0	1	Woodruff key	Clavette
85	615 801077 0	1	Flat wrench 1-1/16"	Clé plate de 27 mm
86	615 504079 0	1	Wheel guard	Protecteur
87	615 503028 0	1	Rear flange	Flasque AR
88	615 502027 0	1	Front flange	Flasque AV
*			Accessory not supplied	Accessoire non fourni

** Flange supplied with flap wheel. To be drilled to fit the diameter of the output shaft of the tool.
 Flasque livré avec la roue à lamelles. À percer au diamètre de l'arbre de sortie de la machine.

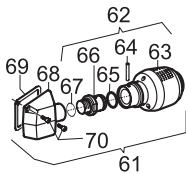

Item Rep	New part no. Réf. standard	Qty Qté	Description	Désignation
61	6153994600	1	Complete silencer kit	Kit silencieux complet
62	399.463	1	Complete silencer	Silencieux complet
63	399.736	1	Silencer	Silencieux
64	637.50	1	Roll pin	Goupille
65	658.164	1	O ring	Joint torique
66	730.172	1	Adapter	Bague de raccordement
67	658.246	1	O ring	Joint torique
68	570.338	1	Collector	Collecteur
69	656.57	1	Gasket	Joint papier
70	616.66	2	Screw	Vis

**CP3239-GABSYGE / CP3249-GABSYGE /
CP3249-GABSUDE / CP3239-GABSYLE**

Part no : 6159945140
Issue no : 02
Seris no : C
Date 03/2012
Page : 5 / 5

Ø 230 (9")

For depressed centre wheel / *Meule à moyeu déporté*

CP3239-GABSYLE

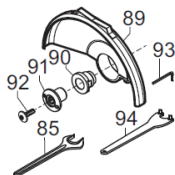

Type 27-41 & 42 wheels
Meule type 27-41 et 42

Item Rep	New part no. Réf. standard	Qty Qté	Description	Désignation
	6153961300	1	Complete kit	<i>Kit complet (85-89-90-91-92-93-94)</i>
85	6158010770	1	Flat wrench 1-1/16"	<i>Clé plate de 27 mm</i>
89	6155041610	1	Wheel guard	<i>Protecteur</i>
90	6155031030	1	Rear flange	<i>Flasque AR</i>
91	6155421040	1	Nut	<i>Écrou</i>
92	6156140340	1	Safety screw	<i>Vis de sécurité</i>
93	6158020560	1	Hex. key 6mm	<i>Clé hex. de 6 mm</i>
94	6158020100	1	Pin wrench 1-3/8"	<i>Clé à ergots entraxe 35 mm</i>

CP3239-GABSYLE

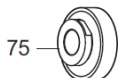

Item Rep	New part no. Réf. standard	Qty Qté	Description	Désignation
75	6155031460	1	Balance hub compl.	<i>Réducteur de vibration</i>



sales@alcornindustrial.com
www.alcornindustrial.com
(800) 317-4775