



# Product Manual

*The Safety Team's Resource  
for Setup, Installation,  
Operation, and Service*

Edition: 8

November 4, 2020

Part number: 17158071-1

**INDUSTRIAL**  

---

**SCIENTIFIC**

Industrial Scientific Corporation, Pittsburgh, PA USA

Industrial Scientific Co., Ltd. Shanghai, China

©2018, 2019, 2020 Industrial Scientific Corporation

All rights reserved. Published 2020.

Revision 9

[www.indsci.com/rgxgateway](http://www.indsci.com/rgxgateway)

# Contents

|  |      |
|--|------|
| Warnings and Cautionary Statements .....                   | v    |
| Certification Summary .....                                | vii  |
| EU Radio Equipment Directive .....                         | viii |
| Chapter 1 .....  | 1    |
| Product Information .....                                  | 1    |
| Product Overview .....                                     | 1    |
| Connected Safety .....                                     | 1    |
| Key Features .....   | 3    |
| RGX Gateway .....  | 3    |
| Communication .....  | 3    |
| LENS repeater mode .....                                   | 5    |
| Compatibilities .....                                      | 6    |
| Instruments .....  | 6    |
| Operational power sources .....                            | 6    |
| Specifications .....                                       | 7    |
| RGX Gateway specifications .....                           | 7    |
| Battery specifications .....                               | 8    |
| Hardware Overview .....                                    | 9    |
| Chapter 2 .....  | 13   |
| Deployment Planning .....                                  | 13   |
| Introduction .....   | 13   |
| Wireless Communications .....                              | 13   |
| RGX Gateway–instrument communication (LENS Wireless) ..... | 13   |
| RGX Gateway–iNet communication .....                       | 14   |
| Wireless settings .....                                    | 14   |
| Wireless connections .....                                 | 15   |
| Chapter 3 .....  | 17   |
| Setup .....  | 17   |
| Introduction .....   | 17   |
| Unpacking .....  | 17   |
| Activation .....   | 18   |
| RGX Gateway .....  | 18   |

|   |    |
|---|----|
| Gas-detection instruments .....                               | 18 |
| Charging the battery .....                                    | 19 |
| Power On and Shutdown .....                                   | 20 |
| Power on.....   | 20 |
| Shutdown.....   | 20 |
| Configuration.....  | 20 |
| Accessing and using the RGX Configuration Interface app ..... | 21 |
| Installation Precheck .....                                   | 28 |
| Chapter 4.....  | 29 |
| Installation and Operation.....                               | 29 |
| Introduction .....  | 29 |
| Site Selection .....  | 31 |
| Placement and Mounting.....                                   | 31 |
| Installation Preparation.....                                 | 31 |
| Installation.....   | 32 |
| Operation Precheck.....                                       | 37 |
| Chapter 5.....  | 39 |
| Service and Warranty .....                                    | 39 |
| Service .....   | 39 |
| Supplies .....  | 39 |
| Instructions.....   | 39 |
| Warranty.....   | 46 |
| Limitation of Liability.....                                  | 46 |
| Appendix A .....  | 47 |
| Appendix B .....  | 50 |
| Appendix C.....   | 51 |
| Applicable Certification Standards.....                       | 51 |
| Contact Information .....                                     | 52 |

# Tables and Figures

|  |      |
|--|------|
| Table 0.1 RGX Gateway hazardous location certifications .....                                  | vii  |
| Table 0.2 RGX Gateway wireless certifications .....  | viii |
| Table 0.3 CE RED radio transmitter types.....  | viii |
| Figure 1.1.A Industrial Scientific connected safety system .....                               | 2    |
| Figure 1.1.B Industrial Scientific connected safety system with RGX in LENS repeater mode..... | 2    |
| Table 1.1 Feature Comparison – RGX Gateway versus RGX in LENS repeater mode.....               | 3    |
| Table 1.2 RGX Gateway compatible gas-detection equipment.....                                  | 6    |
| Table 1.3 RGX compatible power-supply accessories.....   | 6    |
| Table 1.4 RGX Gateway intrinsic safety (IS) input parameters.....                              | 7    |
| Table 1.5 RGX Gateway specifications .....   | 7    |
| Table 1.6 RGX Gateway factory-installed battery specifications.....                            | 8    |
| Figure 1.2.A Hardware overview (exterior) .....  | 10   |
| Figure 1.2.B Hardware overview (interior) .....  | 11   |
| Table 2.1 Required equipment settings for iNet Now live monitoring.....                        | 14   |
| Table 2.2 Range guidelines to maintain LENS Wireless connections.....                          | 15   |
| Table 3.1 Package contents .....   | 17   |
| Figure 3.1 Required setup values .....   | 18   |
| Figure 3.2 Charging the battery .....  | 19   |
| Table 3.2 Configuration applications.....  | 20   |
| Table 3.3 Supplies needed for configuration .....  | 21   |
| Table 3.4 RGX Configuration Interface instruction sets by access method .....                  | 21   |
| Figure 3.3 Wi-fi access method for RGX Configuration Interface .....                           | 22   |
| Figure 3.4 Ethernet access method for RGX Configuration Interface .....                        | 24   |
| Table 3.5 Internal indicator lights* and their meanings .....                                  | 26   |
| Figure 3.5 iNet settings.....  | 27   |
| Table 3.6 Power-button light indicators.....   | 28   |
| Table 4.1 Customer-supplied equipment and services .....                                       | 30   |
| Table 4.2 Possible installation preparation tasks .....  | 32   |
| Table 4.3 RGX installation instruction sets .....  | 33   |
| Figure 4.1 Installation that <i>excludes</i> fixed DC power and Ethernet.....                  | 33   |
| Figure 4.2 Installation that <i>includes</i> an external power source, Ethernet, or both.....  | 34   |
| Figure 5.1 Replaceable parts diagram for the RGX Gateway .....                                 | 40   |
| Table 5.1 RGX Gateway customer replaceable parts list .....                                    | 40   |
| Figure 5.2 Mounting kit and IS cable adapter service tasks.....                                | 41   |
| Figure 5.3 Conduit-hub plug, vent, and port cap service tasks .....                            | 42   |
| Figure A.1.A Control drawing 1810D9509-200 .....   | 47   |
| Figure A.1.B Control drawing 1810D9509-200 .....   | 48   |

Figure A.1.C Control drawing 1810D9509-200, Internal electrical connections ..... 49  
Figure B.1 Control drawing 18109634-200 revision 3 ..... 50

# Warnings and Cautionary Statements

 **CAUTION:** Risk of Explosion. For safety reasons, this equipment must be operated and serviced by qualified personnel only. Read and understand the product manual completely before operating or servicing.

**AVERTISSEMENT:** Risques d'explosion. Pour des raisons de sécurité, cet équipement doit être utilisé, entretenu et réparé uniquement par un personnel qualifié. Étudier le manuel d'instructions en entier avant d'utiliser, d'entretenir ou de réparer l'équipement.

 **WARNING:** Connect only one power input – connecting to multiple power inputs is not supported.

**AVERTISSEMENT:** Ne connectez qu'une seule entrée d'alimentation - la connexion à plusieurs entrées d'alimentation n'est pas prise en charge.

 **IMPORTANT:** Fully charge the RGX™ Gateway before its first use.

 **IMPORTANT:** Only charge the RGX Gateway battery at an ambient temperature range of 5 – 45°C (41 – 113°F).

 **IMPORTANT:** Turn off all external power to the RGX Gateway before servicing the unit.

 **WARNING:** Explosion Hazard. Do not open, maintain, or service where an explosive atmosphere may be present.

**AVERTISSEMENT:** Ne pas ouvrir sous tension. N'ouvrez pas, ne maintenez pas, ou service où une atmosphère explosive peut être présente.

 **WARNING:** Explosion Hazard. Do not connect or disconnect where an explosive atmosphere may be present.

**AVERTISSEMENT:** Risques d'explosion. Ne pas brancher ni débrancher où une atmosphère explosive peut être présente.

 **WARNING:** The RGX Gateway offers these power-input options: 12 V Charger Port, IS Power Port, and 9–30 VDC Terminal Block. When connecting external power, select only a single power-input type; *connecting multiple power inputs is not supported.*

 **CAUTION:** RGX Gateway for use in hazardous locations only as to intrinsic safety per control drawing 1810D9509-200 or 18109634-200.

**AVERTISSEMENT:** RGX Gateway pour une utilisation dans des emplacements dangereux uniquement en ce qui concerne la sécurité intrinsèque par schéma de commande 1810D9509-200 ou 18109634-200

 **WARNING – EXPLOSION HAZARD –** Do not disconnect equipment unless power has been removed or the area is known to be non-hazardous. Potential electrostatic charging hazard. Only clean using a damp cloth.

**AVERTISSEMENT – risque d'EXPLOSION –** ne pas débrancher le matériel sauf si l'alimentation a été coupée ou l'environnement est classé non dangereux: Risque potentiel de charge électrostatique. Nettoyez uniquement avec un chiffon humide.

 **WARNING:** Substitution of components may impair intrinsic safety and may cause an unsafe condition.

**AVERTISSEMENT:** La substitution de composants peut compromettre la sécurité intrinsèque.

 **WARNING:** Connect or disconnect only in a non-hazardous area.

 **CAUTION:** Battery pack is only Industrial Scientific technician replaceable with ISC P/N 17157552; use of another battery may present a risk of fire or explosion. The battery used in this device may present a risk of fire or chemical burn if mistreated: Do not crush, disassemble, or incinerate.

 **IMPORTANT:** Recycle or dispose of batteries according to local laws and regulations.



**IMPORTANT:** Equipment warnings and markings must be legible during normal use. Clean with soft cloth and mild detergent.



This device complies with Part 15 of the FCC Rules for Intentional Radiators. Operation is subject to the following two conditions: (1) This device may not cause harmful interference, and (2) this device must accept any interference received, including interference that may cause undesired operation. Changes or modifications not expressly approved by the manufacturer could void the user's authority to operate the equipment.



This equipment generates and radiates radio frequency energy during normal operation. If not installed in accordance with the installation instructions, it could cause interference with other types of radio communications. Even when installed in accordance with these instructions, interference *could* occur in a specific installation. If it is determined that this equipment is causing interference to radio communications (by turning this equipment off and on), the interference may be corrected by one or more of the following measures:

- Reorient or relocate the receiving antenna.
- Increase the separation between the equipment and receiver.
- Connect the equipment into an outlet on a circuit different from that to which the receiver is connected.
- Consult the dealer or an experienced radio/TV technician for help.



To comply with FCC, ISED, and European Council recommendations on the limitation of exposure of the general public to electromagnetic fields (1999/519/EC), install and operate this device to maintain at least 20 cm (8 inches) separation distance between the RGX Gateway and anywhere personnel may be present for prolonged periods of time.



This device complies with Industry Canada license-exempt RSS standard(s). Operation is subject to the following two conditions: (1) this device may not cause interference, and (2) this device must accept any interference, including interference that may cause undesired operation of the device.

Le présent appareil est conforme aux CNR d'Industrie Canada applicables aux appareils radio exempts de licence. L'exploitation est autorisée aux deux conditions suivantes : (1) l'appareil ne doit pas produire de brouillage, et (2) l'utilisateur de l'appareil doit accepter tout brouillage radioélectrique subi, même si le brouillage est susceptible d'en compromettre le fonctionnement.



This equipment may not cause interference with duly authorized systems and does not have the prerogative to protect against harmful interference.



Industrial Scientific recommends persons with a pacemaker or implantable cardio defibrillator (ICD) should maintain a minimum separation distance of 15 cm (6 ") between the pacemaker or ICD and a wireless-enabled device.

Please consult your physician or the manufacturer of your pacemaker or implantable cardio defibrillator (ICD) manufacturer for additional guidance and recommendations.



It is recommended to not to place this wireless enabled device near any blasting circuits, explosives and detonators.





The RGX Gateway's optional Magnet Mount Kit and individual kit items can cause injury. To avoid injury, Industrial Scientific recommends the following.

- Persons with a pacemaker or implantable cardio defibrillator (ICD) should maintain a minimum separation distance of 90 cm (36 ") between the pacemaker or ICD and the magnet. Please consult your physician or pacemaker or ICD manufacturer for additional guidance and recommendations.
- Neodymium magnets have a strong attractive force. Each can attract quickly when in close proximity to another magnet or metal surface and cause injury. The magnet material is brittle; it can crack or splinter on impact to cause injury and potentially become a flying hazard. Use protective gloves and eyewear to avoid a potentially severe pinch injury, cut, or splinter.
- Do *not* use magnet mounts with units that will draw power from a fixed DC power source.
- Keep magnets away from electronic devices, identification cards, and credit cards that use microchips, magnets, or magnetic fields.

#### ATEX/IECEX/China Ex/CCC Conditions of Safe Use



The equipment must be installed in accordance with the manufacturer's installation drawing number 1810D9509-200 or 18109634-200.



The equipment may pose an electrostatic discharge hazard. When the device is permanently installed as fixed equipment, use only a water-damp cloth when cleaning the device and allow to air dry. When the device is used as transportable equipment, it must be inserted into the Part No.18109549 leather case to address potential electrostatic charging.

## Certification Summary

At the time of this document's publication, the RGX Gateway was certified for use as summarized below. To determine the hazardous-area classifications for which a unit is certified, refer to its label or the equipment order.

The RGX Gateway is suitable for use in non-hazardous locations OR the following classified areas (hazardous locations) ONLY. (Cet équipement peut être utilisé en emplacements non dangereux seulement OU dans les zones classes suivantes (zones dangereuses) UNIQUEMENT.):

Table 0.1 RGX Gateway hazardous location certifications

| Certifying Body       | Classification <sup>a</sup>   | Approved temperature range           |
|-----------------------|---|--------------------------------------|
| ATEX <sup>b</sup>     | Zone 2: Ex ic ec IICT6 Gc<br>DEMKO 19 ATEX 2192X  | -20 °C to +55 °C (-4 °F to + 131 °F) |
| c UL us <sup>b</sup>  | Class I, Division 2: Groups A, B, C, and D,<br>Temperature Code T6<br>Zone 2: Ex ic ec IICT6 Gc (CA)<br>AEx ic ec IICT6 Gc (US) | -20 °C to +55 °C (-4 °F to + 131 °F) |
| CCC <sup>b</sup>      | Zone 2: Ex ic nA IICT6 Gc   | -20 °C to +55 °C (-4 °F to + 131 °F) |
| China Ex <sup>b</sup> | Zone 2: Ex ic ec IICT6 Gc<br>China Ex I: GYJ19.1248X  | -20 °C to +55 °C (-4 °F to + 131 °F) |
| IECEX <sup>b</sup>    | Zone 2: Ex ic ec IICT6 Gc   | -20 °C to +55 °C (-4 °F to + 131 °F) |

Table 0.1 RGX Gateway hazardous location certifications

| Certifying Body | Classification <sup>a</sup>                 | Approved temperature range           |
|-----------------|---|--------------------------------------|
|                 | IECEX 19.0024X                              |                                      |
| INMETRO         | Zone 2: Ex ic ec IICT6 Gc<br>UL-BR 20.1232X | -20 °C to +55 °C (-4 °F to + 131 °F) |

<sup>a</sup>To determine the hazardous-classified areas for which a unit is certified, refer to its label.

<sup>b</sup>See Appendix C for a List of [Applicable Certification Standards](#).

In addition to the certified wireless uses summarized below, refer to the Industrial Scientific website for the most up-to-date information on wireless product [certifications worldwide](#).

Table 0.2 RGX Gateway wireless certifications

| Agency or authority | Identification number   | Country or region |
|---------------------|---|-------------------|
| FCC                 | PHH-RGX, PHH-SM220, SQGBL652, PHH-CC3102MOD, RI7LE910NA, and RI7LE910SV               | USA               |
| ISED-Canada         | 20727-RGX, 7084A-SM220, 3147A-BL652, 451I-CC3120MOD, 5131A-LE910NA, and 5131A-LE910SV | Canada            |

## EU Radio Equipment Directive

The RGX Gateway has been assessed and meets the requirements for the Radio Equipment Directive (CE RED). To determine if your unit is CE compliant refer to the unit's label. The RGX can utilize the following radio transmitter types:

Table 0.3 CE RED radio transmitter types

### GPS Receiver Module

|                      |                             |
|----------------------|-----------------------------|
| Constellation Types: | GPS and GLONASS             |
| Channels:            | GPS: L1C/A<br>GLONASS: L1OF |

### Near Field Communication Radio

|                   |                 |
|-------------------|-----------------|
| Frequency Output: | 13.56 MHz       |
| Maximum Power:    | 23 dBm (200 mW) |

### LENS™ Wireless Mesh Network Radio Transceiver Module (based upon Zigbee radio standard)

|                   |                      |
|-------------------|----------------------|
| Frequency Output: | 2402 MHz to 2480 MHz |
| Maximum Power:    | 9.9 dBm (9.7 mW)     |
| Antenna Gain:     | 0.0 dBi              |

### Bluetooth Low Energy Radio Transceiver Module

Table 0.3 CE RED radio transmitter types

|   |  |                         |
|---|--|-------------------------|
| Frequency Output:                                 | 2405 MHz to 2480 MHz   |                         |
| Maximum Power:                                    | 4 dBm (2.5 mW)   |                         |
| Antenna Gain:                                     | 0.5dBi   |                         |
| Wi-fi Radio Transceiver Module                    |  |                         |
| Supported Channels / Frequencies:                 | 1 thru 13 (2412 MHz to 2472) MHz                                       |                         |
| Maximum TX Power:                                 | 17.0 dBm (50.1 mW) @ 1 DSSS<br>13.5 dBm (22.3 mW) @ 54 OFDM            |                         |
| Antenna Gain:                                     | 1.9 dBi  |                         |
| 3G Cellular Modem Transceiver Module <sup>a</sup> |  |                         |
| 3G Supported Channels / Frequencies (MHz):        | B1 (2100), B2 (1900), B4 (1700/2100), B5 (850), B6 (835), and B8 (900) |                         |
| 2G Fallback Frequencies (MHz):                    | 850, 900, 1800, 1900   |                         |
| Maximum TX Power:                                 | 24 dBm (251 mW)  |                         |
| Antenna Type & Gain(s):                           | 4.3 dBi 698-960 MHz  | 4.1 dBi 1695 – 2200 MHz |
|   | 3.4 dBi 1427.9 – 1510.5 MHz  | 4.6 dBi 2300 – 2700 MHz |
|   | 2.4 dBi 1559 – 1610 MHz  | 4.0 dBi 3400 – 3600 MHz |

<sup>a</sup>Modem excluded from units that are *not* certified for cellular use.



---

## Product Information

Product Overview

Connected Safety

Key Features

Compatibilities

Specifications

Hardware Overview

---

### Product Overview

Gateways and gas-detection instruments from Industrial Scientific can communicate with one another using the company's LENS™ Wireless (Linked Equipment Network for Safety) feature. LENS communications can be transmitted by RGX to iNet® Now—the Industrial Scientific live-monitoring application for cloud-connected safety. The customer sets the RGX to communicate with iNet using the desired transmission options: cellular (if supported), wi-fi, or Ethernet.

RGX can also be used in “repeater mode”, to simply repeat communications it receives without transmitting them to iNet Now. When strategically placed, repeaters fill a distance gap or can bridge would-be obstructed connections among LENS peers.

### Connected Safety

Powerful communications features, equipment, and software complement the gas detection capabilities of Industrial Scientific instruments—*connected safety*—as described and depicted below.

Instruments connected through LENS Wireless share with one another their status (alarms, readings, etc.) allowing peers to learn of nearby hazardous conditions and team members who may be in distress. When RGX is a LENS group peer, instrument data are transmitted through the gateway to iNet and users of iNet Now can virtually “see” the landscape of in-field conditions and the GPS-driven locations of workers in trouble.

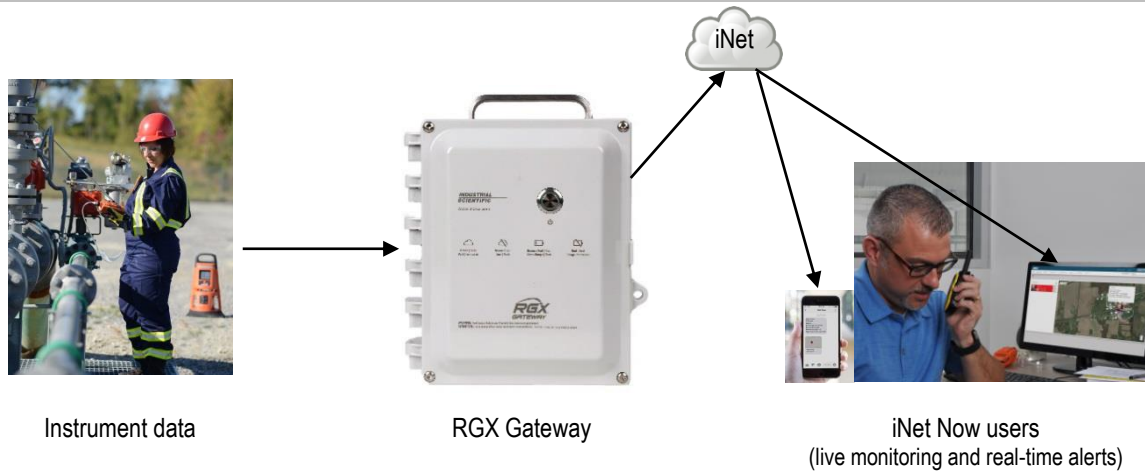

Figure 1.1.A Industrial Scientific connected safety system

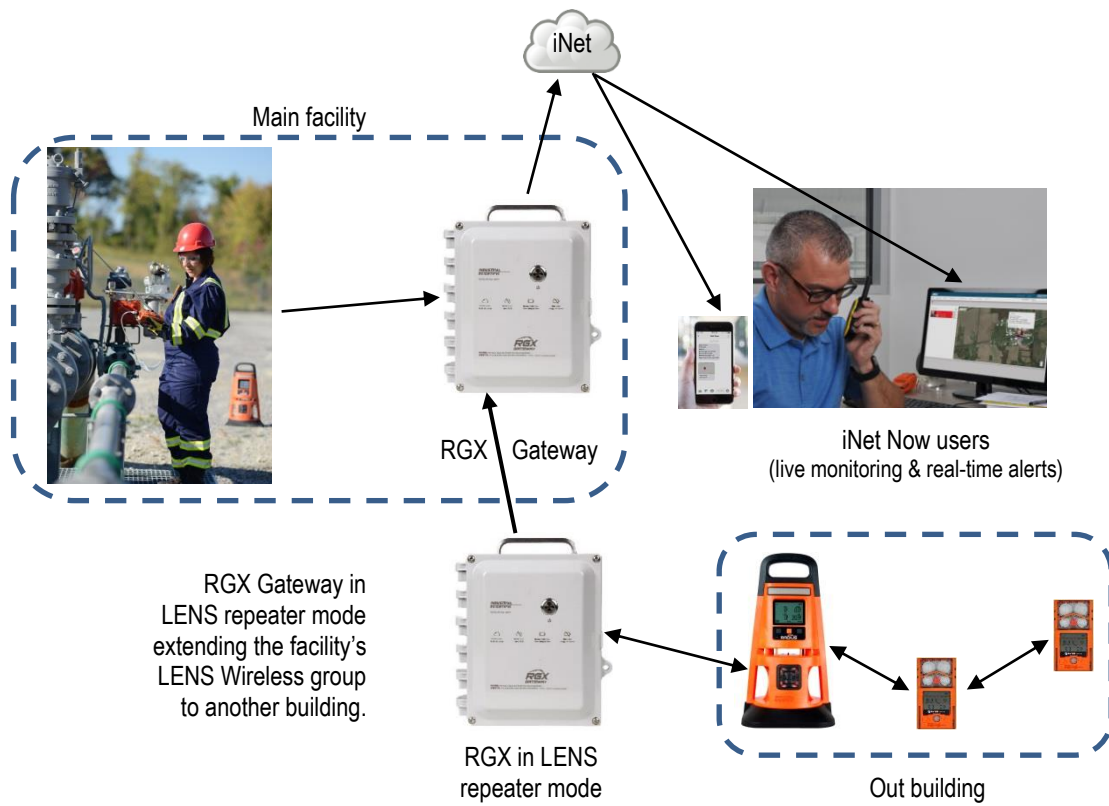

Figure 1.1.B Industrial Scientific connected safety system with RGX in LENS repeater mode

# Key Features

Table 1.1 Feature Comparison – RGX Gateway versus RGX in LENS repeater mode

| Feature                          | RGX Gateway | RGX in LENS repeater mode |
|----------------------------------|-------------|---------------------------|
| Instrument to RGX communications | Yes         | Yes                       |
| RGX to iNet communications       | Yes         | No                        |
| Dynamic monitoring mode          | Yes         | No                        |
| iAssign Beacon functionality     | Yes         | Yes                       |
| Always-on option                 | Yes         | Yes                       |
| Transportable or mountable       | Yes         | Yes                       |
| Multiple power options           | Yes         | Yes                       |
| Indoor* or outdoor operation     | Yes         | Yes                       |

\*Indoor operation is suitable only when GPS location is *not* needed.

## RGX Gateway

### Communication

#### *Instrument–RGX Gateway*

LENS Wireless enables data sharing among wirelessly connected equipment items—gas-detection instruments and RGX Gateway units—that are operating within a LENS group. The following also apply.

- Ten named LENS groups are available.
- Each group can host up to 25 equipment items\*.
- More than one RGX (including LENS repeaters) can be included in a group.

\*Note: The maximum size for each LENS group is 25 equipment items and varies for these specialized applications: 1.) six when a smart-device gateway is in use and 2.) eight when any RGX Gateway in the group is set to Dynamic Monitoring for plume modeling.

Instrument data exchanged through LENS are automatically encrypted with the Industrial Scientific key. Optionally, a customer-supplied encryption key may be used.

#### *RGX Gateway–iNet*

The RGX sends communications it receives from LENS group gas-detection instruments to iNet in the form of *critical* and *noncritical* occurrences.

*Critical events:* Each critical communication is immediately transmitted from RGX to iNet Control. A critical communication generally reaches iNet Control within one minute of the actual event occurrence.

#### Gas detection instruments

- Gas present, high-alarm
- Gas present, low-alarm
- Gas present, over-range (positive and negative) alarm
- TWA (time-weighted average) alarm
- STEL (short-term exposure limit) alarm
- Panic

- Man down
- LENS group instrument events (join, leave, and lost)

#### RGX Gateway

- Gateway critical error
- Gateway online
- Gateway offline

*Noncritical events:* The customer chooses the interval at which the RGX will collectively transmit noncritical communications to iNet Control. The interval range is from one to five minutes. For example, if the interval value is set to 2 minutes and six noncritical events occur within one interval, the RGX will communicate all six in a single transmission to iNet Control. RGX treats the following as noncritical communications:

#### Gas detection instruments

- Pump alarms
- Peer instrument system alarms
- Peer instrument calibration, sensor, and battery events
- Peer instrument user- and site-name updates

#### RGX Gateway

- Site name update

RGX will communicate to iNet its GPS location. Use iNet or the RGX Configuration Interface to set the GPS cycle, the time interval at which the unit will update its location; the cycle value range is from 1 to 60 minutes.

Up to three transmission options are available for RGX—iNet wireless communications: cellular (if supported), wi-fi, and Ethernet. The customer sets each available option to on or off, allowing the RGX to maximize or to limit the number of channels through which it can exchange data with iNet. When more than one transmission option is on, the customer prioritizes the order in which the unit will use them. For example, if wi-fi and cellular are on, the unit can be set to first use wi-fi and if that is not available, use cellular.

The RGX–iNet communications are automatically encrypted using industry standard Transport Layer Security (TLS 1.2).

*Note:* RGX Gateway–iNet communication does not apply to RGX units operating in LENS repeater mode.

#### Location

The RGX Gateway is suitable for indoor or outdoor use in locations that meet the product's [certified uses](#) and [specifications](#). Indoor operation is suitable only when a unit's GPS location is *not* needed.

#### iAssign Beacon functionality

The RGX can function as an iAssign® Beacon. You *must* specify a site name via iNet or the RGX Configuration Interface. Beacon range and access-level can be set via iNet. When an instrument enters or leaves the range assigned to the RGX, the Beacon signal it transmits can:

- Activate an instrument proximity alarm when the access level for an instrument's current user assignment is lower than the access-level setting assigned to the RGX.
- Change an instrument's site assignment.



## Always-On

Through iNet Control, an RGX Gateway can be set for “always-on” operation. Use this feature to prevent manual shutdown attempts in the field. Units operating in this mode *cannot be shut down* and will ignore manual shutdown attempts until this mode is deactivated.

## Mobility and mounting

The versatile RGX Gateway is designed for transportability and for permanent installation. It can be left unmounted for mobile applications or mounted for permanent operation. The RGX features a durable, factory-installed handle, which allows for ready relocation from site to site when mobility is a factor.

- The RGX can be transported in its optional case\*, which provides added protection for the unit, allows you to view the unit's operational status indicator, and access the unit's handle.
- Based on the application, the RGX can be surface mounted or mounted to a customer-supplied strut-type rail installation using the optional Wall Mount Kit.
- The RGX can also be secured to a metal surface using the optional Magnet Mount Kit. **IMPORTANT:** *Do not* use magnet mounts with a unit that will draw power from a fixed DC power source.

\*ATEX-certified units ship with a *required* leather case. The case is available as an *optional* accessory for non-ATEX units.

## Power

The RGX Gateway offers a variety of operational power options.

- The RGX can be powered solely by its rechargeable, factory-installed lithium-ion battery. This option is well suited for *short-term* use conditions that allow for the unit to be situated, between use cycles, in a nonhazardous location for charging.
- The RGX can receive operational power from a compatible, customer-supplied and customer-installed fixed DC power source. This option is suitable for *permanent* installations.
- The RGX can receive operational power from a compatible power-supply accessory only from Industrial Scientific. This option is well suited for use conditions that do not require permanent installation but demand a run time exceeding that of the factory-installed battery.
- *In a nonhazardous location only*, the RGX can draw operational power from its charging power supply.

## Interior case access

The unit's case interior is accessed by removing four screws from the case lid. To help restrict access, the case features tabs to accommodate a customer-supplied lock that is suitable for the location.

The unit features two conduit-hub openings, each sealed with a factory-installed plug. The conduit-hub plugs should *not* be removed except for permanent installations that will make use of customer-supplied conduit-hub fixtures as needed for the connection of a compatible fixed DC power source, Ethernet cable, or both.

## LENS repeater mode

The RGX Gateway can also operate in LENS repeater mode to fill a LENS Wireless distance gap or bridge otherwise obstructed connections. Wireless connectivity among peers in the LENS group is maintained without any additional equipment.

- An RGX unit operating as a LENS repeater relays only its status; no LENS group data is sent to iNet and no data is logged.

- Other RGX units within a LENS group can interact with and send instrument data to iNet.

*Note:* An RGX Gateway operating in LENS repeater mode *can* be upgraded to an RGX Gateway.

## Compatibilities

### Instruments

Use the information supplied below to ensure gas-detection instruments are compatible with the RGX Gateway. As needed, upgrade instrument firmware to the required version, add LENS Wireless functionality, and refer to the instrument's product manual.

Table 1.2 RGX Gateway compatible gas-detection equipment

| Instrument               | Required firmware version | LENS Wireless required | Industrial Scientific <i>Product Manual</i> part number |
|--------------------------|---------------------------|------------------------|---|
| Ventis® Pro Series       | V4.0 or higher            | Yes                    | 17156830  |
| Radius® BZ1 Area Monitor | V4.0 or higher            | Yes                    | 17155915  |

### Operational power sources

**WARNING:** The RGX offers these power-input options: 12 V Charger Port, IS Power Port, and 9–30 VDC Terminal Block. When connecting external power, select only a single power-input type; *connecting multiple power inputs is not supported.*

The RGX can draw operational power from its factory-installed rechargeable lithium-ion battery, which can be charged in a nonhazardous location using the RGX charging power supply. The charging power supply can also be used to provide operational power only when the unit is operated in a nonhazardous location.

The operational run time for the factory-installed battery can be extended with the use of a compatible power-supply accessory only from Industrial Scientific. Each accessory, as listed below, has unique use restrictions or certified uses. Refer to an accessory's *Product Manual* to determine if it suits the application. Before using a power supply accessory, read and understand its product manual and the control drawing 1810D9509-200 or 18109634-200, as represented by the schematic diagrams in [Appendix A](#) or [Appendix B](#) of this manual. These schematics are also included in each power supply's *Product Manual* (part numbers listed below).

Table 1.3 RGX compatible power-supply accessories

| Power supply   | Orderable part number  | <i>Product Manual</i> part number |
|--|--|-----------------------------------|
| Solar Power Supply (SPS)   | 18109634 (power supply)<br>IS cable options for RGX-SPS connection:<br>17159904 (cable, 0.61 m [2'])<br>17159448 (cable, 35 m [38 yd]) | 17159773                          |
| Intrinsically Safe Extended Run Time Power Supply (ISERTPS), Intrinsic Safety (IS) Cable, and the RGX IS Cable Adapter | 18109516 (power supply)<br>17156261 (cable, 50 m [54 yd])<br>18109575 (adapter)  | 17158248                          |

Table 1.3 RGX compatible power-supply accessories

| Power supply   | Orderable part number   | Product Manual part number |
|--|---|----------------------------|
| Extended Run Time Power Supply (ERTPS) Kit<br>(includes IS Cable) and the RGX IS Cable Adapter | 18109388-XA <sup>a</sup> (power-supply kit)<br>17156261 (cable, 50 m [54 yd])<br>18109575 (adapter) | 17158385                   |

<sup>a</sup>Where X indicates regional power-cord type (1 for NA, 2 for EU, 3 for AU, and 4 for UK).

The RGX Gateway's input power parameters are listed below.

Table 1.4 RGX Gateway intrinsic safety (IS) input parameters

| Item           | Value    |
|----------------|----------|
| U <sub>i</sub> | 16.2 VDC |
| I <sub>i</sub> | 0.980 A  |
| P <sub>i</sub> | 2.2 W    |
| C <sub>i</sub> | 0 μF     |
| L <sub>i</sub> | 0 mH     |

The RGX Gateway can be operated using customer-supplied, customer-installed fixed DC power that supplies a compatible input voltage range of 9–30 VDC with a maximum current of 5.0A connected to the dedicated ports on the RGX terminal block. Before connecting power, read and understand control drawing 1810D9509-200 or 18109634-200, as represented by the schematic diagrams in [Appendix A](#) or [Appendix B](#) of this manual.

## Specifications

### RGX Gateway specifications

Ensure all aspects of installation and operation are consistent with the product specifications listed below.

Table 1.5 RGX Gateway specifications

| Item                          | Description   |
|-------------------------------|---|
| Power input                   | Three mutually exclusive options: <ul style="list-style-type: none"> <li>Terminal block: 9–30 VDC, 5.0A (Hazardous Locations)</li> <li>12V power supply: 12VDC, 5.0A (Nonhazardous Locations Only)</li> <li>IS power: 16.2 VDC, 0.980A</li> </ul> |
| Size (length x width x depth) | 28 cm x 23 cm x 15 cm (11 " x 9 " x 6 ")  |
| Weight                        | 2.5 kg (5.6 lb)   |
| Case materials                | Polycarbonate   |
| Ingress protection            | IP64 (outdoor use)  |
| Wet location rated            | Yes   |

Table 1.5 RGX Gateway specifications

| Item                            | Description  |
|---------------------------------|--|
| Environmental rating            | Type 1   |
| Pollution degree                | 2  |
| Overvoltage category            | ≤60 volts  |
| External buttons and indicators |  |
| Buttons                         | One; power button on case lid  |
| Indicators                      | Two <ul style="list-style-type: none"> <li>• Power-button light (colors and patterns indicate operational status)</li> <li>• Indicator light on side panel (indicates battery charging status)</li> </ul>                            |
| Internal buttons and indicators |  |
| Buttons                         | One; SW1 RESET (resets the unit to its original factory-setting values)  |
| Status indicators               | Four <ul style="list-style-type: none"> <li>• COMM indicates communication status.</li> <li>• LENS indicates LENS Wireless status.</li> <li>• ERR2 indicates communication error.</li> <li>• ERR1 indicates system error.</li> </ul> |
| Ethernet indicators             | Two <ul style="list-style-type: none"> <li>• Yellow indicates connection status.</li> <li>• Green indicates connection speed.</li> </ul>   |
| Operating conditions            |  |
| Ambient temperature             | –20 °C to +55 °C (–4 °F to +131 °F)  |
| Humidity                        | 5–95% relative humidity (RH) noncondensing (continuous)  |
| Altitude                        | Use only at altitudes below 2000 m (6560 ')  |
| Storage conditions <sup>a</sup> |  |
| Temperature                     | –40 °C to +70°C (–40 °F to +158 °F)  |

<sup>a</sup>When a unit is stored for more than 30 consecutive days, fully charge the battery before powering on the unit.

## Battery specifications

Run time, operating temperature, and other specifications for the factory-installed battery are listed below.

Table 1.6 RGX Gateway factory-installed battery specifications

| Item                                    | Value                     |
|---|---------------------------|
| Battery type                            | Rechargeable lithium-ion  |
| Run time <sup>a</sup>                   | 168 hours                 |
| Battery charge time <sup>b</sup>        | up to 8 hours             |
| Charging cycles                         | up to 1500 cycles minimum |
| Charging temperature range <sup>c</sup> | 5–45°C (41–113°F)         |

Table 1.6 RGX Gateway factory-installed battery specifications

| Item             | Value               |
|------------------|---------------------|
| Nominal voltage  | 3.65 VDC            |
| Nominal capacity | 16.80 Ah (61.32 Wh) |

<sup>a</sup>Approximate run time when *all* of the following statements are true. The RGX battery is new and fully charged. The RGX is operating at room temperature (25 °C [77 °F]) using any or all communication options. The GPS setting is on and set to send location data every 60 minutes. The LENS group includes up to 25 equipment items. The RGX transmits up to 60 minutes of alarm data every 24 hours and is set to upload noncritical data every five minutes.

<sup>b</sup>When charged at room temperature (25°C [73 °F]).

<sup>c</sup>Battery charging is suspended in temperatures below 5 °C (41 °F) and above 45 °C (113 °F).

## Hardware Overview

The main hardware components of the RGX Gateway are identified below in Figure 1.2.A and Figure 1.2.B (exterior and interior, respectively).

Figure 1.2.A Hardware overview (exterior)

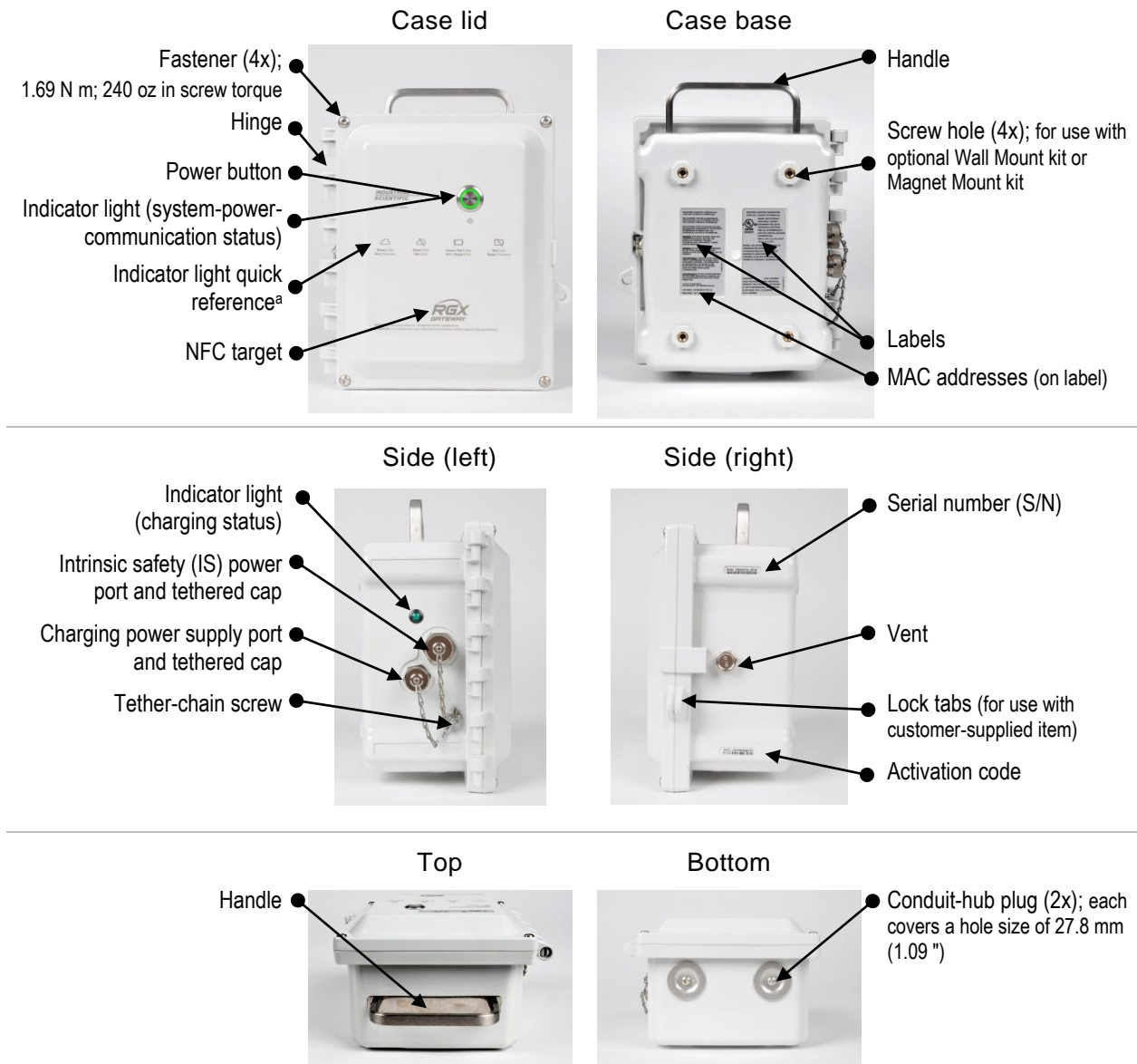

<sup>a</sup>Depicts key connectivity and power light indicators. For a complete list of indicator light patterns and their meanings, see [Table 3.6 Power-button light indicators](#).

Figure 1.2.B Hardware overview (interior)

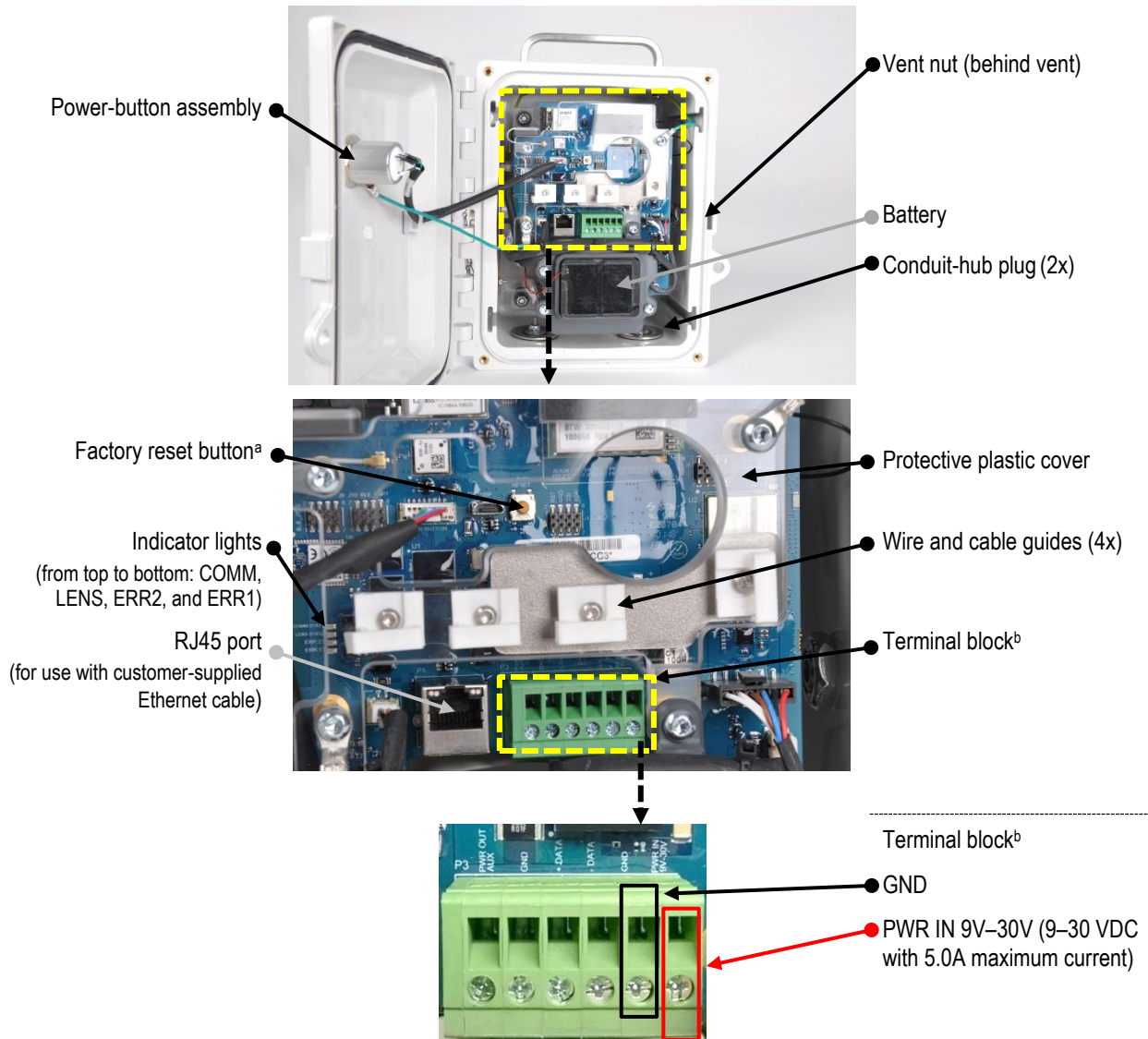

<sup>a</sup>When the factory reset button is pressed and held for approximately 20 seconds, the unit's settings will revert to the original factory-setting values. After a reset, adjust unit settings as needed.

<sup>b</sup>For use with customer-supplied, customer-installed fixed DC power that supplies a compatible input voltage range of 9-30 VDC with a maximum current of 5.0A connected to the dedicated ports on the RGX terminal block.





---

# Deployment Planning

Introduction

Wireless Communications

Settings and Connections

---

## Introduction

Whether you are using a single RGX™ Gateway or multiple units, this chapter will help you make decisions about how each will operate within your organization. An RGX Gateway operating in LENS™ repeater mode connects LENS group peers (instruments and RGX Gateways) maintaining wireless connectivity among peers. Strategic placement of an RGX operating in LENS repeater mode can fill a distance gap or extend a LENS Wireless group.

## Wireless Communications

The RGX communicates using two distinct wireless networks. One network, LENS, allows the RGX to communicate with gas-detection instruments and compatible gateways or repeaters from Industrial Scientific. The other network allows the RGX to send instrument data to iNet®, which supports the live-monitoring capabilities of iNet Now. Both networks are described below.

### RGX Gateway–instrument communication (LENS Wireless)

The RGX can communicate with gas-detection instruments when the equipment items are set to operate in the same named LENS Wireless group (e.g., Group A) or, if available, in LENS scan mode. The following apply to or should be decided for deployment planning and setup preparation.

- Decide in which named LENS group (e.g. "Group A") the RGX will operate.
- A LENS group consists of gas-detection instruments, RGX Gateway units, and optionally RGX units operating in LENS repeater mode.
- Each LENS group can include up to 25 equipment items\*.
- More than one RGX unit can be set to operate in a single LENS Group.
- Decide whether any RGX units operating in LENS repeater mode will be needed to bridge a gap or extend a LENS group.

*\*Note: LENS group size may vary based on settings.*

## RGX Gateway–iNet communication



For deployment planning and setup preparation, determine the following:

- Decide which of the available communication options a unit will use wi-fi, cellular (if supported), and Ethernet.
- If a unit will use more than one option, decide the priority order in which they will be used. For example, if both wi-fi and cellular will be used, a unit can be set to first use wi-fi and if that is not available, use cellular.
- If a unit will use Ethernet or wi-fi determine the type of "network protocol" connection it will use—*dynamic* or *static*. For more information, contact your network administrator.

## Wireless settings

The settings itemized in Table 2.1 are required for iNet Now live monitoring of LENS group peers.

Table 2.1 Required equipment settings for iNet Now live monitoring

|                                  | Equipment items   |  |   |
|----------------------------------|---|--|---|
|                                  |  |               |  |
| Setting item                     | RGX Gateway <sup>a</sup>  | Ventis Pro   | Radius BZ1  |
| LENS Wireless                    | No setting required   | Menu: Wireless<br>Setting: LENS Wireless<br>Value: iNet Now and Local                          | Menu: Wireless<br>Setting: Wireless Radio<br>Value: iNet Now and Local              |
| LENS Wireless Group <sup>b</sup> | Menu: LENS Wireless<br>Setting: LENS Group<br>Value: Group X <sup>b</sup>         | Menu: Wireless<br>Setting: LENS Wireless,<br>LENS Group<br>Value: Group X <sup>b</sup> or Scan | Menu: Wireless<br>Setting: Group<br>Value: Group X <sup>b</sup> or Scan             |
| Encryption key <sup>c</sup>      | Menu: LENS Wireless<br>Setting: Encryption Key<br>Value: Automatic or custom      | Menu: Wireless<br>Setting: LENS Wireless,<br>Encryption<br>Value: Automatic or custom          | Menu: Wireless<br>Setting: Encryption<br>Value: Default or custom                   |

<sup>a</sup>Also applies to RGX units operating in LENS repeater mode.

<sup>b</sup>If a named LENS Group (e.g., Group A) is used, all equipment items must be set to the same LENS group or, if available, to scan. X" is used here to indicate the value will be a single character in length; the available values are the letters A through J.

<sup>c</sup>All equipment items must be set to the same encryption key. "Default" or "automatic" sets the unit's LENS Wireless to the Industrial Scientific encryption key, and "custom" to the customer's key. If a custom key will be used, some setup is also required in iNet.

You will need to make decisions about the RGX GPS and noncritical data settings.

- Determine if the unit will operate with its GPS on or off. When on, the unit can acquire its GPS coordinates and send this location data to iNet. Importantly, the GPS data are used by iNet Now users to identify the location of an RGX that has sent data from an in-alarm gas detector. Location data are also useful for tracking units that will be transported among sites. If the unit's GPS will be on, determine the interval (1–60 minutes) at which the unit will send its location data to iNet.

- Determine the interval (minutes) at which the unit will send its noncritical data to iNet to support the live-monitoring capabilities of iNet Now.

When setting intervals, consider the application. For example, while a longer interval for sending GPS data uses less battery power, a shorter interval may be better suited if the RGX will be frequently moved among sites.

## Wireless connections

Industrial Scientific equipment can have wireless operations enabled for a variety of features and functions. Units used in an indoor environment *cannot* receive the signal required for GPS functionality.

During operation, unintended interference can weaken wireless signals. The following in-field practices can sometimes enhance signal strength and may affect site selection.

- GPS is supported by ample outdoor, open-sky access.
- Mount or place each RGX using a vertical orientation, the handle's top facing the sky.
- As needed, adjust ground-to-unit distance to 1 m (3' 3") or more.
- Adjust positioning relative to nearby buildings or their walls, floors, and ceilings, and other structures such as a vehicle or machinery.
- Place the unit to ensure it is not shielded.
- Be as knowledgeable as possible of any dead zones that can interfere with cellular transmission.

Use the range guidelines supplied below to maintain each connection type.

Table 2.2 Range guidelines to maintain LENS Wireless connections

| Equipment items                  | Line-of-sight distance, maximum |  |                             |
|----------------------------------|---------------------------------|--|-----------------------------|
|                                  |                                 | LENS Power Mode Setting<br>World setting | CE RED <sup>b</sup> setting |
| <b>RGX to equipment items</b>    |                                 |  |                             |
| RGX to RGX <sup>a</sup> (World)  | —                               | 300 m (328 yd)                           | 185 m (202 yd)              |
| RGX to RGX <sup>a</sup> (CE RED) | —                               | 185 m (202 yd)                           | 185 m (202 yd)              |
| RGX to Ventis Pro                | 100 m (109 yd)                  | —  | —                           |
| RGX to Radius BZ1                | —                               | 300 m (328 yd)                           | 185 m (202 yd) <sup>c</sup> |
| <b>Instrument to instrument</b>  |                                 |  |                             |
| Ventis Pro to Ventis Pro         | 100 m (109 yd) <sup>b</sup>     | —  | —                           |
| Ventis Pro to Radius BZ1         | 100 m (109 yd) <sup>b</sup>     | —  | —                           |
| Radius BZ1 to Radius BZ1         | —                               | 300 m (328 yd)                           | 185 m (202 yd) <sup>c</sup> |

<sup>a</sup>Also applies to RGX units operating in LENS repeater mode: RGX to LENS repeater, LENS repeater to LENS repeater, and LENS repeater to RGX.

<sup>b</sup>For more information see [EU Radio Equipment Directive](#) in the *front matter* of this manual.

<sup>c</sup>Applies when the equipment items face each other.

To learn more about the Ventis Pro® or the Radius® BZ1, consult its product manual.



---

## Setup

Introduction

Unpacking

Activation

Charging the battery

Power On and Shutdown

Configuration

Installation Precheck

---

## Introduction

Only qualified personnel should setup the RGX™ Gateway.

Choose a setup area in a *nonhazardous location* with a clean, uncluttered surface on which to work. Ensure that a power source compatible with the unit's charging power supply cord is present.

Additional setup needs will be listed throughout this chapter. Needs will vary based on a unit's intended placement, operational power source, communication settings, and other factors.

## Unpacking

During the unpacking process, account for and examine each ordered item. If any item is missing or appears to have been damaged, contact [Industrial Scientific](#) or an authorized distributor of Industrial Scientific products. After unpacking, peel the protective plastic film from the case lid.

Table 3.1 Package contents

| Quantity   | Item  | Description   |
|------------|---|---|
| As ordered | RGX Gateway                                       | Transmits data between compatible, enabled Industrial Scientific gas-detection instruments and iNet.        |
| As ordered | or<br>RGX Gateway operating in LENS repeater mode | Extends the range of a LENS group but does not transmit any instrument data or events to iNet.              |
| As ordered | Charging power supply and power cord              | 12 VDC power supply with customer-ordered cord that fits <i>one</i> power source type (AUS, EU, NA, or UK). |
| 1          | Document  | Warnings and Cautionary Statements  |

---

The values noted below, unique to each RGX, are required for setup.

---

Figure 3.1 Required setup values

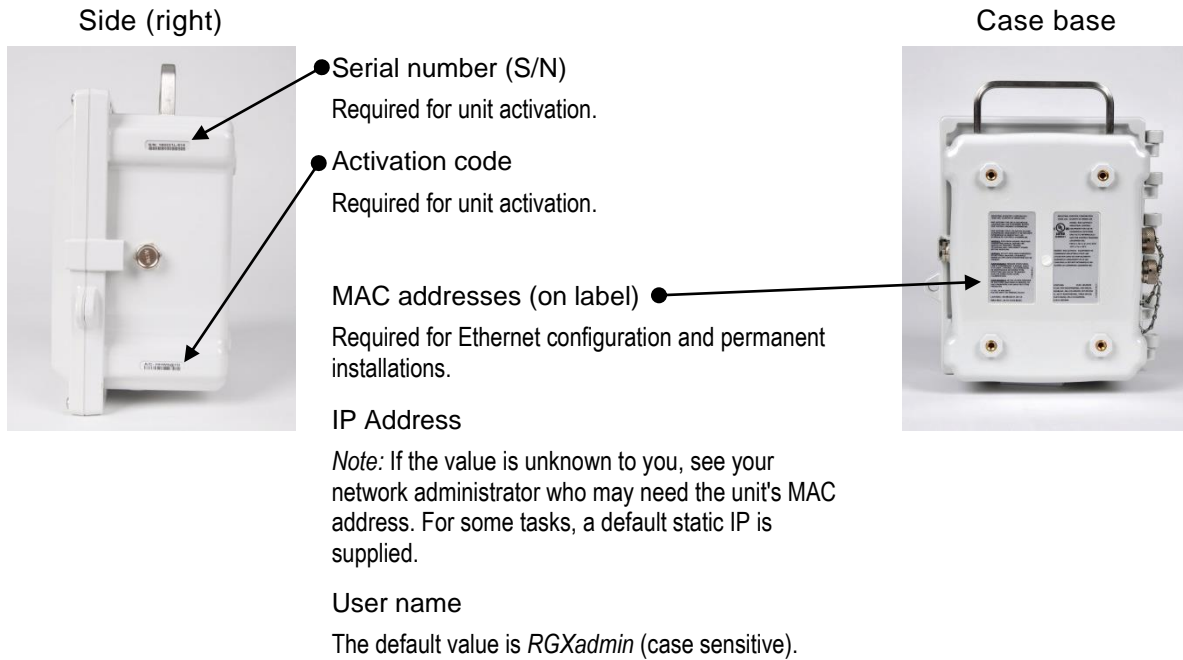

## Activation

### RGX Gateway

Log into iNet® and follow this navigation.

- Click on the *Equipment* tab.
- Choose *Activate New Equipment*.
- In the appropriate fields, enter the unit's *Serial Number* and *Activation Code*.
- Use the OK button to submit the information.

*Note:* When an RGX has not yet been activated, or when deactivated, the power button light will slowly blink red. See [Table 3.6 Power-button light indicators](#) for more information. In this state the RGX cannot connect to iNet to relay instrument events.

### Gas-detection instruments

To transmit gas-detection instrument data wirelessly from instrument to RGX to iNet and onto the users of iNet Now, the instruments must be activated for live monitoring. The following are required.

- Access to iNet.
- The Serial Number (S/N) for each instrument to be monitored.

Log into iNet and follow this navigation.

- Click on the *iNet Now* tab.
- Choose *iNet Now Activations*.
- Use the serial number search box to locate an instrument.
- An item's *Activated* check-mark box indicates an instrument is activated for live monitoring.

# Charging the battery

Using *only* the supplied RGX charging power supply and power cord, charge the unit's installed battery as shown and described below.

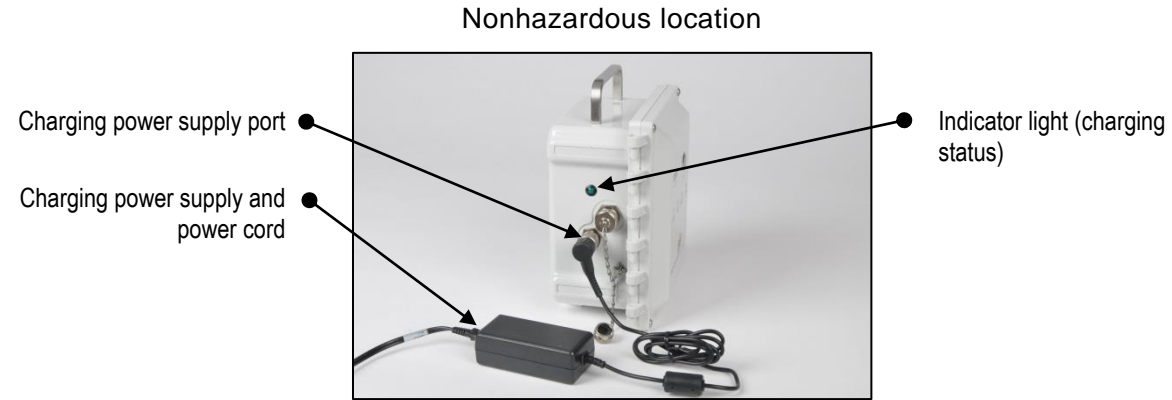

Connect the charging power supply to its power cord.



Uncap the unit's charging power supply port: turn the port cap counterclockwise to expose the port for use.



Connect the power-supply cable to the port and turn its swivel cover clockwise (approximately 45°) until it clicks closed or a full-stop connection feedback is felt. Plug the power cord into a compatible outlet.



Check the unit's charging-status indicator light.

- The green light will first *blink* on and off to indicate a precharging state.
- The green light will stay on, but stop blinking, to indicate charging is in progress.
- The light will turn *off* to indicate the battery is fully charged.



When the battery is fully charged, unplug the power cord from the outlet. Disconnect the cable from the port: turn its swivel cover counterclockwise (approximately 45°).



Cap the charging power supply port: turn its swivel cover clockwise (approximately 45°) until it clicks closed or a full-stop connection feedback is felt. *Note:* always cap a port when it is not in use.

Figure 3.2 Charging the battery

# Power On and Shutdown

Locate the power button on the case lid.

## Power on

Press the power button for approximately 5 seconds until the power-button light turns on.

- If the unit is fully operational, the power-button light will be solid (not blinking) green.
- For information about other light patterns and colors, see [Table 3.6 Power-button light indicators](#).

## Shutdown

Press the power button for approximately 7 seconds.

- When the power-button light starts to blink, release the button.
- To indicate unit shutdown is in progress, the light will blink red and green.
- To indicate the unit is fully shutdown, the light will turn off.

*Note:* An RGX Gateway set for “always-on” operation *cannot be manually shut down* and will ignore manual shutdown attempts until this setting is changed via iNet.

# Configuration

RGX configuration requires the use of one or two "apps", the RGX Configuration Interface (Interface) and iNet software. Generally, as outlined below, the Interface is used to configure RGX-to-iNet communication settings; iNet is used for all other RGX settings (see below). See each app for other settings. After initial configuration, use each app as needed to edit the settings it supports.

Table 3.2 Configuration applications

|   | App                         |                     |
|---|-----------------------------|---------------------|
|   | RGX Configuration Interface | iNet software       |
| Supported settings  |                             |                     |
| Always-on power functionality   | No                          | Yes                 |
| iAssign Beacon (access level and range)                                     | No                          | Yes                 |
| LENS repeater mode  | No                          | Yes                 |
| LENS Wireless (group and encryption key)                                    | No                          | Yes                 |
| Dynamic Monitoring mode <sup>a</sup>  | No                          | Yes                 |
| RGX-iNet communication (cellular, wi-fi, and Ethernet options and priority) | Yes                         | Yes (priority only) |
| Site name (also serves as Beacon site name)                                 | Yes                         | Yes                 |
| GPS options   | Yes                         | Yes                 |

<sup>a</sup>Supports iNet Now but reduces LENS Wireless maximum group size.



## Accessing and using the RGX Configuration Interface app

If the unit's communication setting will be cellular *only*, then you do *not* need to access or complete any work in the RGX Configuration Interface; skip to [Figure 3.5 iNet settings](#).

There are two methods for accessing the RGX Configuration Interface—through a wi-fi or Ethernet connection. Supplies required for each access method are listed below.

Table 3.3 Supplies needed for configuration

| Item                            | Access method     |          |
|---------------------------------|-------------------|----------|
|                                 | Wi-fi             | Ethernet |
| Torx screwdriver with a T25 bit | No                | Yes      |
| Ethernet cable Cat5 or greater  | No                | Yes      |
| Computer (with browser)         | No                | Yes      |
| Smart device (with browser)     | Yes (or computer) | No       |
| RGX Serial Number (S/N)         | Yes               | Yes      |
| Access to iNet                  | Yes               | Yes      |

When using the RGX Configuration Interface, the following apply.

- If you are not familiar with your company's communication protocols, see your network administrator for assistance.\*
- If your company's wireless network uses "WPA2-Enterprise" security, the RGX Interface will require the upload of a *certificate of authenticity* that is 2048-bit or less and supplies the full chain of trust.\*
- As with most applications, the Interface is subject to timing out when idle.
- When a data field appears in gray, *no* entry is required.
- Within each section, work from top to bottom.
- When a "test" button appears, use it after entering all the required values that precede it; then, follow any on-screen instruction to learn of and correct for any invalid or missing values.

\*These items do not apply to an RGX Gateway operating in LENS repeater mode.

Based on your access method, wi-fi or Ethernet, complete *only one* of two possible instruction sets as indicated below.

Table 3.4 RGX Configuration Interface instruction sets by access method

| Access Method | Instruction set |            |
|---------------|-----------------|------------|
|               | Figure 3.3      | Figure 3.4 |
| Wi-fi         | Yes             | No         |
| Ethernet      | No              | Yes        |

Figure 3.3 Wi-fi access method for RGX Configuration Interface

1 Power on the RGX



On the case lid, press the power button for approximately 5 seconds until the power-button light turns on. Observe the power-button light and proceed as noted below.

- Green only** (blinking or solid) Continue.
- Includes red** (blinking or solid) See [Table 3.6 Power-button light indicators](#) before continuing.
- Light does not turn on Try again. If the condition persists, the unit may not have sufficient charge. Charge the unit before continuing.

2 Activate Wi-fi access mode



Tap the power button three times quickly. If the power-button light **blinks red**, continue; otherwise, try again.

3 Log into the RGX Configuration Interface



Check the smart device for a list of detected wi-fi devices:

- Locate the serial number for the unit; highlight it and click on it.
- When prompted to enter a security key, enter 0 (zero) followed by the RGX's [activation code](#).

On the smart device, open a browser:

- In the browser address bar enter https:// followed by the RGX IP address.
- If the IP address is unknown, enter: 192.168.1.1

When prompted, enter the log-in credentials below to access the RGX Configuration Interface:

- User name: RGXadmin (case sensitive)
- Password: Unit [activation code](#)

*Note:* It is recommended that the password be changed after initial log in. The case-sensitive password requirements follow.

Use a minimum of 8 characters in any order, including minimally, at least:

- one number
- one lowercase letter
- one uppercase letter
- one symbol from this set: () ` ~ ! @ # \$ % ^ & \* - + = | \ { } [ ] ; : " ' < > , . ? /

4 Configure options



Access *Settings*

RGX Gateway only

- Review the RGX-iNet communications options: cellular, wi-fi, and Ethernet. Enable or disable each available option.
- For each enabled option, enter, select, or edit the required values.

*Reminder:* If your company's wireless network uses "WPA2-Enterprise" security, the RGX Interface will require the upload of a *certificate of authenticity* that is 2048-bit or less and supplies the full chain of trust.

RGX Gateway operating in LENS repeater mode

Site name can be set. All other settings must be edited in iNet.

*Save and Reboot*

When finished, click save; the Interface will prompt you to confirm the save.

When prompted to reboot, click on the prompt, then confirm. No other action is needed, the software will complete the reboot.

---

5 Verify RGX Gateway operation



To verify the unit is operational, observe the power-button light. If it is green and not blinking, the unit is operational. For information about other indicator-light patterns and colors, see [Table 3.6 Power-button light indicators](#).

Next go to [Figure 3.5](#) and follow the instructions to use iNet, where you will complete all other settings.

---

Figure 3.4 Ethernet access method for RGX Configuration Interface

1 Shut down the RGX



Set the unit on the work surface, case lid facing up.

Observe the power-button light.

- If the light is *off*, continue.
- If the light is on and *green* only (blinking or solid), *shut down the unit*. Press the power button for approximately 7 seconds; when its light starts blinking, release the button. The power-button light will blink red and green to indicate shutdown is in progress; it will turn off to indicate the unit is fully shutdown.
- If the light is on and includes *red* light (blinking or solid), see [Table 3.6 Power-button light indicators](#) before continuing.

2 Access unit interior



Using a torx screwdriver with a T25 bit, unscrew and remove the four screws that secure the case lid to the case base.

Set aside the screws for later reinstallation.

The case is hinged on the left; open its lid from right to left.

3 Connect Ethernet cable; power on unit

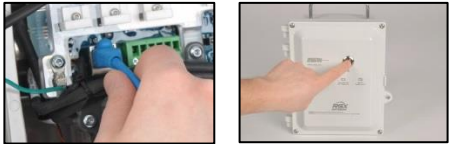

Before connecting the Ethernet cable, you will need to ensure the computer and the RGX are on the same network. Consult your network administrator for assistance. *Note:* For network connections, the default static IP is 192.168.1.1.

Next, connect one end of the customer-supplied Ethernet cable (Cat5 or greater) to the computer, then connect the other end to the Ethernet port.

Power on the RGX: On the case lid, press the power button for approximately 5 seconds. Observe the power-button light and proceed as noted below.

- |                                  |   |
|----------------------------------|---|
| Green only (blinking or solid)   | Continue.   |
| Includes red (blinking or solid) | See <a href="#">Table 3.6 Power-button light indicators</a> before continuing.  |
| Light does not turn on           | Try again; be sure to hold the power button for a full 5-second count. If the condition persists, the unit may not have sufficient charge. Charge the unit before continuing. |

4 Observe interior LEDs\*



Observe the interior LEDs located near the left edge of the PCB (printed circuit board). From top to bottom, they are labeled COMM STAT, LENS STAT, ERR2, and ERR1. Each light may be on or off.

Check the ERR2 light (third from top). At this point, it may be red; continue.

\**Note:* If operating on battery power only, the interior LEDs will *not* be on.



## 5 Log into the RGX Configuration Interface

On the computer, open a browser;

- In the address bar enter `https://` followed by the RGX IP address.
- If the IP address is unknown, enter: 192.168.1.1

When prompted, enter the log-in credentials below to access the RGX Configuration Interface:

- User name: RGXadmin (case sensitive)
- Password: Unit [activation code](#)

*Note:* It is recommended that the password be changed after initial log in. The case-sensitive password requirements follow.

Use a minimum of 8 characters in any order, including minimally, at least:

- one number
- one lowercase letter
- one uppercase letter
- one symbol from this set: () ` ~ ! @ # \$ % ^ & \* - + = | \ { } [ ] ; ' " < > , . ? /



## 6 Configure options

*Access Settings*

RGX Gateway only

- Review the RGX-iNet communications options: cellular, wi-fi, and Ethernet. Enable or disable each available option.
- For each enabled option, enter, select, or edit the required values.

*Reminder:* If your company's wireless network uses "WPA2-Enterprise" security, the RGX Interface will require the upload of a *certificate of authenticity* that is 2048-bit or less and supplies the full chain of trust.

RGX Gateway operating in LENS repeater mode

Site name can be set. All other settings must be edited in iNet.

*Save and Reboot*

When finished, click save; the Interface will prompt you to confirm the save.

When prompted to reboot, click on the prompt, then confirm. No other action is needed, the software will complete the reboot.

## 7 Status check

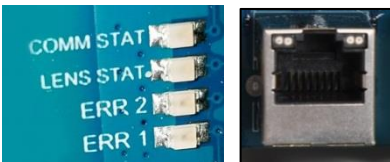

Observe the LEDs\* inside the case and compare them to the "operational status" column in [Table 3.5](#) below.

- The LENS Wireless status light will be off until another equipment item joins the LENS group; otherwise, if there are no errors or connection issues, disconnect the Ethernet cable from the unit.
- If there are errors or issues, recheck the work completed to this point. If an issue persists, contact Industrial Scientific.
- Disconnect the cable from the computer and, as needed, reconfigure the computer to the desired network.

*\*Note:* If operating on battery power only, the interior LEDs will *not* be on.



8 Close case lid and secure to case base

Close the case lid and ensure all wires and cables are:

- secure
- contained entirely inside the case
- away from the unit's closure surfaces.

Reinstall the four fasteners with the T25 torx bit to secure the case lid to the case base. Screw torque: 1.69 Nm (240 oz in)

Go to [Figure 3.5](#) and follow the instructions to use iNet where you will complete all other RGX settings.

Table 3.5 Internal indicator lights\* and their meanings

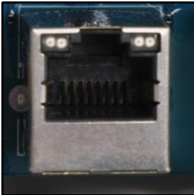
| Label   | Indicator | Light                      | Operational status |   |
|---|-----------|----------------------------|--------------------|---|
|   | COMM STAT | iNet connection status     | Green              | The unit has a connection to iNet; if blinking green, data are being exchanged.                   |
|   |           |                            | Off                | The unit has <i>no</i> connection to iNet.  |
|   | LENS STAT | LENS Wireless status       | Green              | LENS Wireless is operational; if blinking green, data are being exchanged.                        |
|   |           |                            | Off                | Either LENS Wireless is <i>not</i> operational or no other equipment items are in the LENS group. |
|  | ERR2      | Communication status       | Red                | There is a communications error.  |
|   |           |                            | Off                | There is <i>no</i> communications error.  |
|   | ERR1      | System status              | Red                | There is a system error.  |
|   |           |                            | Off                | There is <i>no</i> system error.  |
| Ethernet cable port   | Left LED  | Ethernet connection status | Green              | There is <i>no</i> Ethernet connection.   |
|   |           |                            | Off                | There is an Ethernet connection.  |
|   | Right LED | Ethernet connection speed  | Yellow             | The Ethernet connection is 10 Mb.   |
|   |           |                            | Off                | The Ethernet connection is 100 Mb.  |

\*Note: To conserve battery power, the interior LEDs will *not* be on if operating on battery power only. Connect to an external power input to check the LED status indicator lights.

Figure 3.5 iNet settings

1 Log into iNet

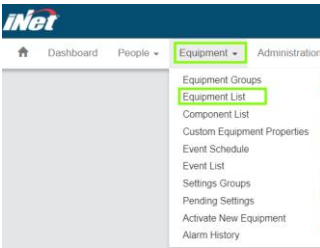

Follow this navigation.

- Click on the *Equipment* menu.
- Choose *Equipment List*.

At the equipment list page (not shown), use the search box associated with the *Serial Number* column to enter the unit's serial number.

Click on the unit's serial number; the unit's information will display.

2 Configure LENS Wireless and General settings

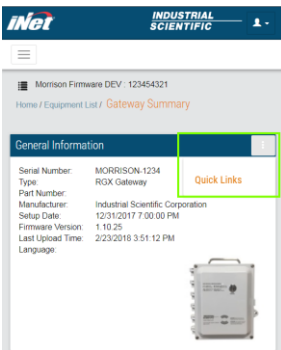

Go to settings.

- Use the *Quick-links* box (shown) or
- Scroll the page to *Options*, click on *Edit*

In the *LENS Wireless* and *General* sections, complete these settings.

- GPS<sup>a</sup>
- noncritical data interval<sup>a</sup>
- communication priorities
- LENS group name
- LENS group encryption key
- Always-on / Disable Shutdown<sup>b</sup>
- iAssign Beacon settings:
  - BLE Range Access: 1m (3.3 ft), 5m (16.4 ft), 20m (65.6 ft), or 30 m (98.4 ft)
  - Restriction Access Level<sup>c</sup> – Set the access level for the Beacon.
  - Site name

<sup>a</sup>When setting intervals, consider the application. For example, while a longer GPS interval uses less battery power, a shorter interval may be better suited if the unit is to be frequently moved among sites.

<sup>b</sup>An RGX Gateway set for “always-on” power cannot be manually shut down and will ignore manual shutdown attempts until this mode is deactivated via iNet.

<sup>c</sup>When an instrument enters or leaves the Beacon range assigned to the RGX and the access level for the instrument's user assignment is lower than the access-level setting assigned to the RGX this could cause an instrument proximity alarm.

| Activated ↑                         | Serial Number |
|-------------------------------------|---------------|
| Checked ▾                           |               |
| <input checked="" type="checkbox"/> | 15102HT-002   |
| <input checked="" type="checkbox"/> | 170400R-001   |

3 If the gas-detection instruments have not yet been activated for live monitoring, follow this navigation.

- Click on the *iNet Now* tab.
- Choose *iNet Now Activations*.

Use the serial number search box to locate an instrument. A check mark in the *Activated* column indicates an instrument is activated for live monitoring.

# Installation Precheck

Power on the unit if it is not already on. Observe the power-button light on the case lid and compare it to the "operational status" column in Table 3.6 below.

- If there are no errors or issues, *shut down the unit*.
- If there are any issues, recheck the work completed to this point. If an issue persists, contact Industrial Scientific.

Table 3.6 Power-button light indicators

| Color and state                              |   | Operational status   |
|--|---|--|
| Green only                                   |   |  |
| Solid (not blinking)                         |    | The unit is operational.   |
| Rapid blinking                               |    | The unit is trying to communicate with iNet.   |
| Slow blinking                                |       | The unit is communicating with iNet but its GPS* is not working.<br>or<br>The unit cannot communicate with iNet.   |
| Very slow blinking<br>(once every 4 seconds) |    | RGX is set to LENS repeater mode.  |
| Both green and red                           |   |  |
| Alternating                                  |    | Low battery warning<br>or<br>The power button has been pressed and the unit is shutting down.  |
| Red only                                     |   |  |
| Solid (not blinking)                         |    | The unit is not operational because there is no power.   |
| Rapid blinking                               |    | Indicates that wi-fi access mode has been activated.   |
| Slow blinking                                |   | Indicates that the unit is inactive (never activated or currently deactivated), See also <a href="#">Activation</a> for more information.<br>or<br>An error has occurred that requires resolution. Power off, then power on the unit. If the issue persists, contact Industrial Scientific |
| Light is off                                 |   | The unit is powered off or the battery is completely discharged.   |

\*Status is indicated only when feature is enabled.



---

# Installation and Operation

Introduction

Site Selection

Placement and Mounting

Installation Preparation

Installation

Operation Precheck

---

## Introduction

Only qualified personnel should install and operate the RGX™ Gateway.

To help prevent injury and damage to the equipment, handle the unit with care and avoid dropping it.

**NOTICE:** A customer's intended use of the RGX may require mounting, as well as the installation of a compatible fixed DC power source, an Ethernet connection, or both. These and other tasks will require the customer acquisition and use of equipment, tools, and services. All customer-supplied equipment, tools, and services required to install (or uninstall), mount, or otherwise secure (or remove) the unit must comply with and be used in ways that meet any restrictions imposed by the hazardous-classified area; local, state, or national codes, regulations, standards, permits, or other requirements; and the Authority Having Jurisdiction (AHJ). The wiring of intrinsically safe circuits follows these examples.

- NFPA 70 National Electric Code (NEC); Article 504
- CSA C22.1 Canadian Electric Code (CEC); Appendix J 18-152
- IEC/EN 60079-14 Electrical installations

**CAUTION:** RGX Gateway for use in hazardous locations only as to intrinsic safety per control drawing 1810D9509-200 or 18109634-200.

**AVERTISSEMENT:** RGX Gateway pour une utilisation dans des emplacements dangereux uniquement en ce qui concerne la sécurité intrinsèque par schéma de commande 1810D9509-200 ur 18109634-200.

A list of possible customer-supplied equipment items and services is provided below.

Table 4.1 Customer-supplied equipment and services

| Item  | Purpose  | Restrictions <sup>a</sup>  |
|---|--|--|
| Mounting (optional)   |  |  |
| Mounting surface and mounting equipment items                                 | Mounting the unit for operation.   | The mounting surface must support 10.9 kg (24 lb) static weight and must meet any weight-bearing requirements of the customer-supplied mounting equipment.<br><br>A strut-type kit or strut-type rails and fasteners for mounting are suitable for a permanent installation. A unit can also be surface mounted.   |
| Wall Mount Kit from Industrial Scientific                                     | For use with surface mounting or strut-type mounting   | See the <a href="#">Service</a> section of this manual for instructions.<br><br><i>Note:</i> The kit includes a label that replicates important information printed on the back of the RGX, including the LAN MAC and WAN MAC values. Copy these two values onto the kit label in the designated spaces. Affix the label to an area of the unit that will be visible during operation. |
| Magnet Mount Kit from Industrial Scientific                                   | For use with metal surface mounting  | <i>Do not</i> use with units that will draw power from a fixed DC power source.<br><br>See the <a href="#">Service</a> section of this manual for instructions.  |
| <hr/>   |  |  |
| Power source, external (optional)   |  |  |
| Fixed DC power source   | Operational power suitable for permanent installations.  | 9–30 VDC with a maximum current of 5.0A.<br><br>Hubs and conduits suitable for the application and hole size 27.8 mm (1.09 ").   |
| Electric power ISERTPS from Industrial Scientific                             | Operational power suitable for extended run-time installations.  | Before using the ISERTPS, ensure your application meets the product's certified uses and restrictions: read and understand the ISERTPS <i>Product Manual</i> (part number 17158248).   |
| Electric power ERTPS from Industrial Scientific                               | Operational power suitable for extended run-time installations.  | Before using the ERTPS, ensure it suits your application: read and understand its <i>Product Manual</i> (part number 17158385). <i>Note:</i> Except for its IS cable, the ERTPS is <i>not</i> certified for use in any hazardous-classified areas.   |
| Solar-sourced power SPS, from Industrial Scientific                           | Operational power suitable for extended run-time installations.  | Before using the SPS, ensure your application meets the product's certified uses and restrictions: read and understand its <i>Product Manual</i> (part number 17159773).   |
| <hr/>   |  |  |
| Supplies (optional)   |  |  |
| Torx screwdriver set with T20, T25, and T30 bits<br><br>3/8 " open-end wrench | Removal or installation of conduit-hub plugs (T20 screwdriver and 3/8 " wrench), wall mounts (T30), and case fasteners (T25) | Suitable for the installation location.  |

Table 4.1 Customer-supplied equipment and services

| Item             | Purpose  | Restrictions <sup>a</sup>   |
|------------------|--|---|
| Other (optional) |  |   |
| Ethernet cable   | Required only for units that will use Ethernet during operation. | Cat5 (or greater) Ethernet cable with a 90° strain relief, and an RJ45 modular connector, that supports 10/100 Ethernet. For longer cables, 14–110 m (46–360 '), use a solid conductor shielded twisted pair cable. |
| Lock             | Restricts access to the unit's interior.                         | Suitable for the installation location.   |

<sup>a</sup>All customer-supplied equipment, tools, and services must comply with and be used in ways that meet any restrictions imposed by the hazardous-classified area; local, state, or national codes, regulations, standards, permits, or other requirements; and the AHJ.

## Site Selection

Choose an operational location (site) that achieves the following:

- Compliance with the product's [certified use restrictions](#) and [product specifications](#).
- Supports guidelines and practices to establish or maintain [wireless connections](#).
- Permits opening a mounted unit's door, which is hinged on its left side.
- Accommodates conduit of the required length for units that will be connected to a compatible customer-supplied, customer-installed fixed DC power source, Ethernet cable, or both.
- Ensure that the unit and any cable or cord connections are situated away from standing water.
- If used with the ISERTPS or ERTPS ensure sufficient space for the Intrinsic Safety (IS) Cable Adapter, which attaches to the IS power port on the left side of the unit.

Reminder: Units used in an indoor environment *cannot* receive the signal required for GPS functionality.

## Placement and Mounting

The unit can be placed or mounted for operation.

The optional Wall Mount Kit can be used for a unit that will be mounted to a wall, another surface, or to a strut-type rail setup. The kit contains a label that replicates important information printed on the back of the RGX, including the LAN MAC and WAN MAC values. Copy these two values onto the kit label in the designated spaces. Affix the label to an area of the unit that will be visible during operation.

The optional Magnet Mount Kit is used to mount the unit to a metal surface. **IMPORTANT:** *Do not* use the Magnet Mount Kit with units that draw operational power from a fixed DC power source.

## Installation Preparation

Based on how the RGX will be mounted (or placed) and its intended operational power source and communications options, use the information below to determine which preparation tasks are needed. Refer to the [Service](#) section of this manual for task instructions.

Table 4.2 Possible installation preparation tasks

| Application   | Service task   |
|---|--|
| <b>Mounting</b>   |  |
| Wall, surface, strut-type rail mounting                                     | Wall-mount installation  |
| Magnet mounting   | Magnet-mount installation; <i>do not use magnet mounts</i> with units that will draw operational power from a fixed DC power source  |
| <b>Operational power source</b>   |  |
| Compatible power-supply accessory from Industrial Scientific                | IS Cable Adapter installation (only required for connection to ERTPS and ISERTPS)  |
| Fixed DC power source   | Conduit-hub plug removal   |
| Conversion from fixed DC power source to any other operational power source | Acquire the Conduit-hub Plug Kit and complete installation. <i>Do not</i> reinstall any used conduit-hub plug components; once removed a plug's seal is compromised and other plug components may become altered or damaged. |
| <b>Communication</b>  |  |
| Ethernet  | Conduit-hub plug removal   |
| Conversion from Ethernet to non-Ethernet                                    | Acquire the Conduit-hub Plug Kit and complete installation. <i>Do not</i> reinstall any used conduit-hub plug components; once removed a plug's seal is compromised and other plug components may become altered or damaged. |

## Installation

The RGX Gateway is suitable for use in Class I, Division 2 Groups A, B, C and D and Zone 2 classified areas OR non-hazardous locations only.

- Class I, Division 2: Groups A B C D; Temp Code T6
- Zone 2: AEx ic ec IICT6 Gc
- Ambient Temperature -20°C to +55°C

*Note:* For a list of applicable hazardous location certifications, see [Table 0.1 RGX Gateway hazardous location certifications](#).

**WARNING:** The RGX offers these power-input options: 12 V Charger Port, IS Power Port, and 9–30 VDC Terminal Block. When connecting external power, select only a single power-input type; *connecting multiple power inputs is not supported*.

Based on the operational power the unit will use and whether an Ethernet connection will be installed, complete *only one* of two possible instruction sets as indicated below in Table 4.3. *Read the full instruction set before starting*. Along with the information supplied in the instruction set, meet the requirements of the AHJ, and consult the control drawing 1810D9509-200 or 18109634-200, as represented by the schematic diagrams in [Appendix A](#) or [Appendix B](#) of this manual.

Table 4.3 RGX installation instruction sets

|   | Instruction set |            |
|---|-----------------|------------|
|   | Figure 4.1      | Figure 4.2 |
| Power-Ethernet combination                                  |                 |            |
| <i>Excludes</i> fixed DC power and Ethernet                 | Yes             | No         |
| <i>Includes</i> an external power source, Ethernet, or both | No              | Yes        |

### Figure 4.1 Installation that *excludes* fixed DC power and Ethernet

If your installation *excludes* connecting *both* fixed DC power *and* Ethernet, continue below with step 1; otherwise, use the instruction set in Figure 4.2.

- 1 Mount or place RGX  
If the unit has been prepared for mounting, use the customer-supplied equipment and services to complete the mounting task; otherwise place the unit at the desired operational location.

- 2 Port caps and power cables  
Choose *only* one option below (a, b, or c) regarding the operational power input for the RGX and follow that set of instructions.  
**WARNING:** The RGX offers these power-input options: 12 V Charger Port, IS Power Port, and 9–30 VDC Terminal Block. When connecting external power, select only a single power-input type; *connecting multiple power inputs is not supported*.  
When installing a port cap or connecting a power supply cable to a port, push the cap or cable slightly, then turn its swivel connector clockwise (approximately 45°) until it clicks closed or a full-stop connection feedback is felt.

- a *No external power source*  
If the RGX will draw operational power *only* from its factory-installed battery, cap the charging power-supply port *and* the IS power port.



[Skip to Operation Precheck.](#)

- b *Power supply accessory (SPS, ISERTPS, or ERTPS)*

**IMPORTANT:** The *warning* above also applies to this option.

If the RGX will draw operational power from a compatible power supply accessory, cap the RGX charging power-supply port.

Ensure the power supply is installed, connected, and used in accordance with the instructions provided in its product manual.

[Skip to Operation Precheck.](#)





c *Charging power supply (part number 17158665)— use only in a nonhazardous location*

**IMPORTANT:** The *warning* above also applies to this option.

If the unit will be operated in a nonhazardous location and will draw operational power using the RGX charging power supply, cap the RGX IS power port.

Uncap the unit's charging power supply port to expose the port for use; connect the power-supply cable to the port. Plug the cord into a compatible electrical outlet.

[Skip to Operation Precheck.](#)

Figure 4.2 Installation that *includes* an external power source, Ethernet, or both

If your installation *includes* the connection of an external power source, an Ethernet cable, or both, continue below with step 1; otherwise, use the instruction set supplied in Figure 4.1.

1 De-energize *external* power source

If the RGX will be connected to an external power source\*, *de-energize the external power source.*

\*A customer-supplied and customer-installed fixed DC power or a compatible power-supply accessory from Industrial Scientific.

2 Shut down the RGX

Observe the RGX power-button light.

- If the light is *off*, continue.
- If the light is on and *green* only (blinking or solid), *shut down the unit.* Press the power button for approximately 7 seconds; when its light starts blinking, release the button. The power-button light will blink red and green to indicate shutdown is in progress; it will turn off to indicate the unit is fully shutdown.
- If the light is on and includes *red* light (blinking or solid), see [Table 3.6 Power-button light indicators](#) before continuing.

Note: An RGX Gateway set for “always-on” operation cannot be manually shut down and will ignore manual shutdown attempts until this mode is deactivated via iNet.



3 Port check

Cap each power port that will *not* be used for operational power (charging power port and IS power port shown here).

When installing a port cap, push the cap slightly, then turn its swivel connector clockwise (approximately 45°) until it clicks closed or a full-stop connection feedback is felt.



---

#### 4 Label check



The Wall Mount Kit includes a label that replicates important information printed on the back of the RGX, including the LAN MAC and WAN MAC values. Copy these two values onto the kit label in the designated spaces. Affix the label to an area of the unit that will be visible during operation.

---

#### 5 Mount or place the RGX

If the unit has been prepared for mounting, use the customer-supplied equipment and services to complete the mounting task; otherwise, place the unit in the desired operation location.

---

#### 6 Access case interior



When working inside the unit, avoid contact with the battery, other exposed components, and any item protected by the unit's interior plastic cover. Avoid dropping or spilling anything into the case.

- Using a torx screwdriver with a T25 bit, unscrew and remove the four fasteners that secure the case lid to the case base. Set aside the fasteners for later reinstallation.
- The unit is hinged on the left; open the case lid from right to left.
- Bring in the customer-supplied Ethernet cable, power lines, or both through the customer-installed conduit-hub. If both an Ethernet cable and fixed DC power will be used, it is recommended that one conduit be used for the Ethernet cable and the other for the power lines, following AHJ requirements.
- Use the diagram below, left, to locate the optional connection ports to be used: the terminal block, Ethernet cable port, and guides.

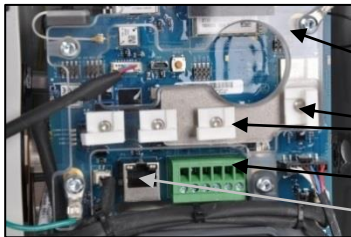

- Protective cover
- Guides (4x)
- Terminal block
- RJ45 port

---

#### 7 Connect power

Choose *only* one option below (a or b) to select an external power input for the RGX and follow that set of instructions.

**WARNING:** The RGX offers these power-input options: 12 V Charger Port, IS Power Port, and 9–30 VDC Terminal Block. When connecting external power, select only a single power-input type; *connecting multiple power inputs is not supported.*



a Power supply accessory (SPS, ISERTPS, or ERTPS)

**IMPORTANT:** The *warning* above also applies to this option.

If the RGX will draw operational power from the ISERTPS or ERTPS, connect the power supply's IS cable to the unit's IS Cable Adapter; otherwise, omit the adapter when using the SPS.

Ensure that the power supply is installed, connected, and used in accordance with the instructions provided in its product manual.

Skip to step 8.

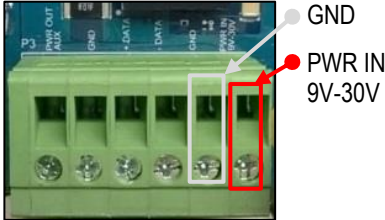

Terminal block (detail)

b Fixed DC power

**IMPORTANT:** The *warning* above also applies to this option.

To complete the fixed DC power connections, count the terminal-block ports from left to right, locating the fifth and sixth ports.

- Connect the ground line to Port 5, labeled "GND".
- Connect the compatible fixed DC power line to Port 6, labeled "PWR IN 9V-30V ". This line supplies input voltage in the specified range with a maximum current of 5.0A.
- Use these mechanical and electrical wiring specifications.

Mechanical:

- Solid Wire: 18-12 AWG
- Stranded Wire: 18-12 AWG
- Torque: 4.0 lb in (0.45 N m)

Electrical: Shield wiring, or conduit, at the source



8 Connect optional Ethernet cable

If an Ethernet connection will be used, connect the cable to its port.



9 Secure the cable and power line

Use the guides to secure the already connected Ethernet cable and power line.

- Lift any guide by its tab.
- Place the cable or power line in the guide's groove.
- Lower and secure the tab to the guide base.



10 Close case lid and secure to case base

Ensure all wires and cables are:

- secure
- contained entirely inside the case
- away from the unit's closure surfaces

This supports the integrity of the items and full closure of the lid Close the case lid from left to right.

Using a T25 torx screwdriver, reinstall the four fasteners that secure the case lid to the case base. Tighten them to a torque value of 1.69 N m (240 oz in).



## Operation Precheck

Power on the unit: On the case lid, press the power button for approximately 5 seconds until the power-button light turns on.

Observe the color and pattern of the power-button light, which indicates the unit's operational status. If the light is solid green (not blinking)\* the unit is fully operational. For information about other indicator-light patterns, refer to [Table 3.6 Power-button light indicators](#) for more information.

*\*Note:* When an RGX Gateway operating in LENS repeater mode is fully operational its power-button light displays a very *slowly* blinking green light.



---

# Service and Warranty

---

## Service

Service tasks for the RGX™ Gateway should be performed only by qualified personnel under the following conditions.

- Perform service tasks *only* in a nonhazardous area.
- If an external power source is connected, de-energize the power source before servicing the unit.
- Ensure the unit is powered off; observe the power-button indicator light is off.
- Use only approved Industrial Scientific parts and accessories.
- Work on a nonconductive surface in a well-lit area.
- Wear grounding straps to prevent electrostatic discharge (ESD), which can damage the unit.
- To support ingress protection, refer to Table 5.1 and tighten the items to their stated torque values.
- When working with the magnet mounts, the following apply.
  - Do not drill or abrade magnets; their powdered form is highly flammable.
  - Use protective gloves and eyewear to avoid a potentially severe pinch injury, cut, or splinter.

Service tasks that can be completed by Industrial Scientific customers are described in this manual. Table 5.1 indicates which parts and components are customer replaceable. All other service tasks should be performed *only* by Industrial Scientific or its authorized service centers.

## Supplies

### Torx screwdriver set

- T10 bit for port cap replacement
- T20 bit for conduit-hub plug removal or installation
- T25 bit for case fasteners
- T30 bit for wall mounts

### Open-end wrenches

- 1/4 " for port cap replacement
- 3/8 " for conduit-hub plug removal or installation
- 3/4 " for vent replacement
- 18 mm for vent replacement

### Additional supplies

- Isopropyl alcohol for fixed gasket replacement.

## Instructions

Figure 5.1 provides partially disassembled views of the RGX Gateway, identifying customer replaceable parts and components. This is followed by Table 5.1, which provides information about each part.

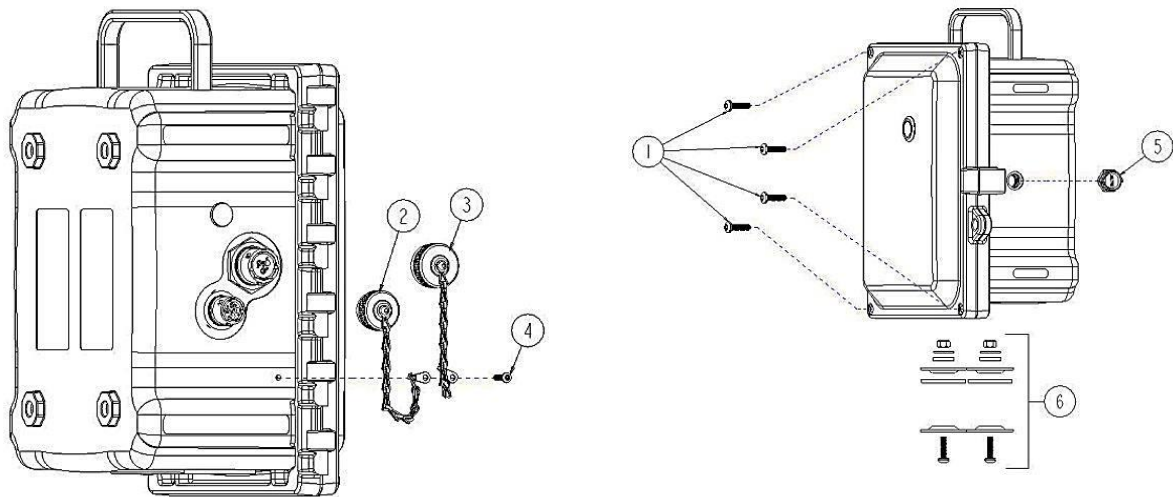

Figure 5.1 Replaceable parts diagram for the RGX Gateway

Table 5.1 RGX Gateway customer replaceable parts list

| Diagram number     | Part name              | Part number | Notes   |
|--------------------|------------------------|-------------|---|
| <b>RGX</b>         |                        |             |   |
| 1                  | Case fastener          | 18109573    | Four fasteners per pack<br>Fastener torque: 1.69 Nm (240 oz in)   |
| 2                  | Charging port cap      | 18109570    | Includes tether-chain, screw, sealing gasket, washers and hex nut.  |
| 3                  | IS power port cap      | 18109571    | Includes tether-chain, screw, sealing gasket, washers and hex nut.  |
| 4                  | Tether-chain screw     | —           | Screw torque: 0.63 Nm (90 oz in)  |
| 5                  | Vent                   | 18109572    | Vent nut torque: 1.27 Nm (180 oz in)  |
| 6                  | Conduit-hub plug       | 18109574    | Screw torque: 1.27 Nm (180 oz in)   |
| <b>Accessories</b> |                        |             |   |
| —                  | Wall Mount Kit         | 17157620    | Screw torque: 1.13 to 1.69 Nm (160 to 240 oz in)  |
| —                  | Magnet Mount Kit       | 18109564    | <i>Do not use</i> with a unit that will draw power from a DC fixed power source.<br>Each magnet has a pull force of 67.6 kgf (149 lbf). |
| —                  | IS power cable adapter | 18109575    | Length: 62.2 cm (24.5 "); only for use with the ISERTPS and ERTPS   |

Figure 5.2 Mounting kit and IS cable adapter service tasks

Wall Mount Kit installation



Using the orientation shown, mate the hexagon cutout of the wall mount to a corresponding corner on the back of the RGX. The cross portion will extend past the edge of the case.



Using a T30 torx screwdriver, turn the torx screw clockwise to tighten.

Screw torque: 1.13 to 1.69 Nm (160 to 240 oz in)



Install the remaining wall mounts.



In the kit, locate the supplied label, which replicates important information printed on the back of the RGX.



Locate the unit's LAN MAC and WAN MAC values, printed on the factory affixed label on the back of the unit. Record these two values onto the kit label in the areas provided.



Affix the kit label to an area of the RGX that will be visible during operation.

Magnet Mount Kit installation

*Do not use with a unit that will draw power from a DC fixed power source.*



Insert magnet post into a threaded screw hole on the back of the case; turn clockwise to tighten.



Repeat for second magnet installation.



The two magnets may be installed in the following configurations: top, bottom, left side, right side, and diagonal.

Two magnet mounts will support the weight of the RGX; up to four magnets may be installed.

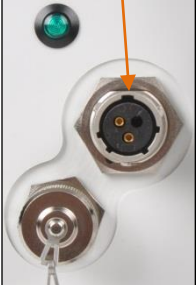
## Intrinsic Safety (IS) Cable Adapter installation

|   |  |   |  |
|---|--|---|--|
|   | <p>IS Cable Adapter connector</p> <p>Arrow</p>  | <p>RGX IS port</p> <p>Wide notch</p>  |  |
|  | <p>Turn the IS power port cap counterclockwise (approximately 45°) to expose the port for use.</p>                               |                                      | <p>Align the arrow on the top of the adapter connector to the wide notch on the IS port; push on to the port to connect.</p> <p>Turn the swivel connector clockwise (approximately 45°) until it clicks closed or a full-stop connection impact is felt.</p> |



—

Connect the other end of the adapter in accordance with the *Product Manual* instructions from the compatible Industrial Scientific power-supply accessory that will be used.

Figure 5.3 Conduit-hub plug, vent, and port cap service tasks

### Opening the case



Use a T25 torx screwdriver to unscrew and remove the four fasteners that secure the case lid to the case base; set aside the screws for later reinstallation.



The unit is hinged on the left; open the lid from right to left.

### Closing the case



When closing the lid, ensure all wires and cables are secure and are contained inside the case, away from its closure surfaces.



Reinstall the four fasteners with the T25 torx bit to secure the case lid to the case base. Screw torque: 1.69 Nm (240 oz in)

---

## Conduit-hub plug removal and installation

### Conduit-hub plug removal

*Do not* reinstall any used conduit-hub plug components; once removed, a plug's seal is compromised and other plug components may become altered or damaged.



Locate the conduit-hub plugs at the bottom of the case base.



Inside the case, hold the nut in place with a 3/8 " open-end wrench and turn the T20 torx screw counterclockwise to loosen.

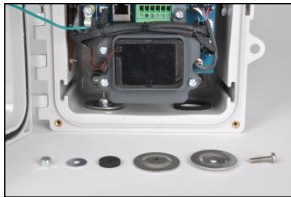

Remove the nut, two internal washers, the sealing gasket, and one external washer from the case.



To remove a worn or damaged fixed gasket, push the outer edge of the gasket toward its center with a finger; use friction and a forward motion to separate the gasket from the base.



Use the glue side of the removed gasket in a dabbing motion to lift off remaining adhesive.

Rub all gasket-glue residue with a finger from the case base and clean the area with isopropyl alcohol.



## Conduit-hub Plug Kit installation

Use only an unused Conduit-hub Plug Kit from Industrial Scientific.

Do not reinstall any used conduit-hub plug components; once removed, a plug's seal is compromised and other plug components may become altered or damaged.

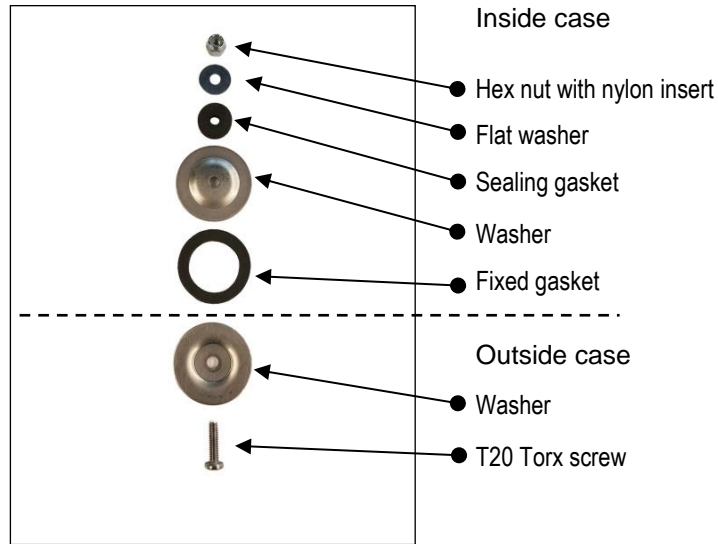

Remove the protective paper to expose the adhesive side of the gasket.

Inside the case, center and place the gasket over the conduit-hub plug opening on the base.



From outside of the case, place the torx screw into the concave side of the washer, and place over the base opening.



Inside the case, place the next washer—convex side down—over the screw and fixed gasket.



Follow with the sealing gasket, flat washer, and hex nut.



Hold the hex nut in place with a 3/8 " open-end wrench and turn the T20 torx screw clockwise to tighten.

Screw torque: 1.27 Nm (180 oz in)



## Vent replacement

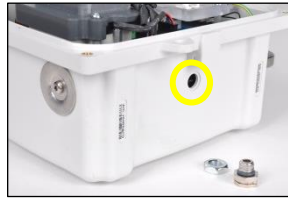
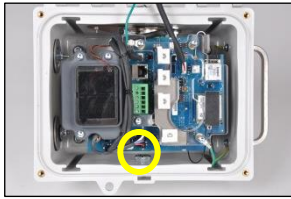

To remove the vent, use an 18 mm open-end wrench to hold the vent in place.

Inside the case, turn the nut counterclockwise with a 3/4 " open-end wrench to loosen and remove.

Discard the items according to company policy.

Insert the replacement vent into the hole from outside of the case.

Inside the case, screw the nut onto the vent threads clockwise.

Hold the vent in place with the 18 mm open-end wrench; use the 3/4 " open-end wrench to turn the nut clockwise to tighten.

Vent nut torque: 1.27 Nm (180 oz in)

## Port cap removal and installation (IS port cap shown)

### Port cap removal



To remove a worn or damaged port cap, locate the hex nut for the tethered-chain screw inside the case.

Hold the hex nut in place with a 1/4 " open-end wrench and turn the T10 torx screw counterclockwise to loosen.

Inside the case, remove the nut, and one flat washer. Lift the copper ground shield to remove the second flat washer and sealing gasket\*\*.

Turn the port cap counterclockwise approximately 45°; separate from the port.

Discard the removed items according to company policy.

### Port cap installation

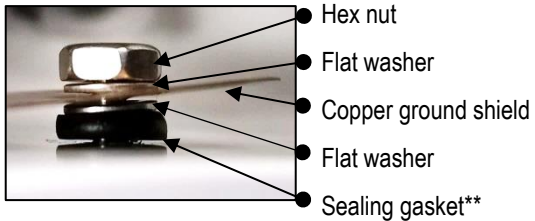

Connect the replacement port cap\* to the appropriate port (IS port or Charging port): turn clockwise (approximately 45°) until it clicks closed or a full-stop connection impact is felt.

Insert the T10 torx screw through both tether-chain end rings, and into the case screw hole.

\* Always cap the port when it is not in use.

Inside the case, lift the copper ground shield enough to place the sealing gasket\*\* and flat washer over the tether-chain screw; follow with the copper ground shield, second flat washer, and hex nut.

Hold the hex nut in place with a 1/4 " open-end wrench and turn the T10 torx screw clockwise to tighten.

Screw torque: 0.63 Nm (90 oz in)

\*\*Replace the sealing gasket with every tether-chain screw disassembly.

## Warranty

Industrial Scientific Corporation's RGX™ Gateways are warranted to be free from defects in material and workmanship under normal and proper use and service for twenty-four (24) months from date of shipment. This warranty includes batteries, except where otherwise stated in writing in the literature accompanying the product. Industrial Scientific warrants that it will provide a cellular data plan for the life of the Gateway, for a minimum of two years from time of purchase provided the customer maintains an active iNet® Now account during that time; however, Industrial Scientific reserves the right to terminate any cellular data plan, at its sole discretion, in the case of misuse by Buyer, including but not limited to using data for purposes other than those described in this user manual and using data in regions outside of those originally purchased.

### Limitation of Liability

THE WARRANTY SET FORTH ABOVE IS STRICTLY LIMITED TO ITS TERMS AND IS IN LIEU OF ALL OTHER WARRANTIES, GUARANTEES, EXPRESS OR IMPLIED, ARISING BY OPERATION OF LAW, COURSE OF DEALING, USAGE OF TRADE OR OTHERWISE. INDUSTRIAL SCIENTIFIC MAKES NO OTHER WARRANTIES, EITHER EXPRESSED OR IMPLIED, INCLUDING BUT NOT LIMITED TO THE WARRANTIES OF MERCHANTABILITY OR FITNESS FOR PARTICULAR PURPOSE.

SHOULD THE PRODUCT FAIL TO CONFORM TO THE ABOVE WARRANTY, BUYER'S ONLY REMEDY AND INDUSTRIAL SCIENTIFIC'S ONLY OBLIGATION SHALL BE, AT INDUSTRIAL SCIENTIFIC'S SOLE OPTION, REPLACEMENT OR REPAIR OF SUCH NON-CONFORMING GOODS OR REFUND OF THE ORIGINAL PURCHASE PRICE OF THE NONCONFORMING GOODS.

IN NO EVENT WILL INDUSTRIAL SCIENTIFIC BE LIABLE FOR ANY OTHER SPECIAL, INCIDENTAL, CONSEQUENTIAL, PUNITIVE OR OTHER SIMILAR DAMAGES, INCLUDING LOSS OF PROFIT OR LOSS OF USE, ARISING OUT OF THE SALE, MANUFACTURE OR USE OF ANY PRODUCTS SOLD HEREUNDER WHETHER SUCH CLAIM IS PLEADED IN CONTRACT OR IN TORT, INCLUDING STRICT LIABILITY IN TORT AND WHETHER INDUSTRIAL SCIENTIFIC HAS BEEN ADVISED OF THE POTENTIAL FOR SUCH DAMAGES. Industrial Scientific's total liability hereunder from any cause whatsoever (except liability from personal injury caused by Industrial Scientific's negligence), whether arising under contract, warranty, tort (including negligence), strict liability, products liability or any other theory of liability, will be limited to the lesser of Buyer's actual damages or the price paid to Industrial Scientific for the Products that are the subject of Buyer's claim. All claims against Industrial Scientific must be brought within one year after the cause of action arises, and Buyer expressly waives any longer statute of limitations.

It shall be an express condition to Industrial Scientific's warranty that all products be carefully inspected for damage by Buyer upon receipt, be properly calibrated for Buyer's particular use, and be used, repaired, and maintained in strict accordance with the instructions set forth in Industrial Scientific's product literature. Repair or maintenance by non-qualified personnel will invalidate the warranty, as will the use of non-approved consumables or spare parts. As with any other sophisticated product, it is essential and a condition of Industrial Scientific's warranty that all personnel using the products be fully acquainted with their use, capabilities and limitations as set forth in the applicable product literature.

Buyer acknowledges that it alone has determined the intended purpose and suitability of the goods purchased. It is expressly agreed by the parties that any technical or other advice given by Industrial Scientific with respect to the use of the goods or services is given without charge and at Buyer's risk; therefore, Industrial Scientific assumes no obligations or liability for the advice given or results obtained.

# Appendix A

Supplemental information about the Extended Run Time Power Supply (ERTPS) and the Intrinsically Safe Extended Run Time Power Supply (ISERTPS).

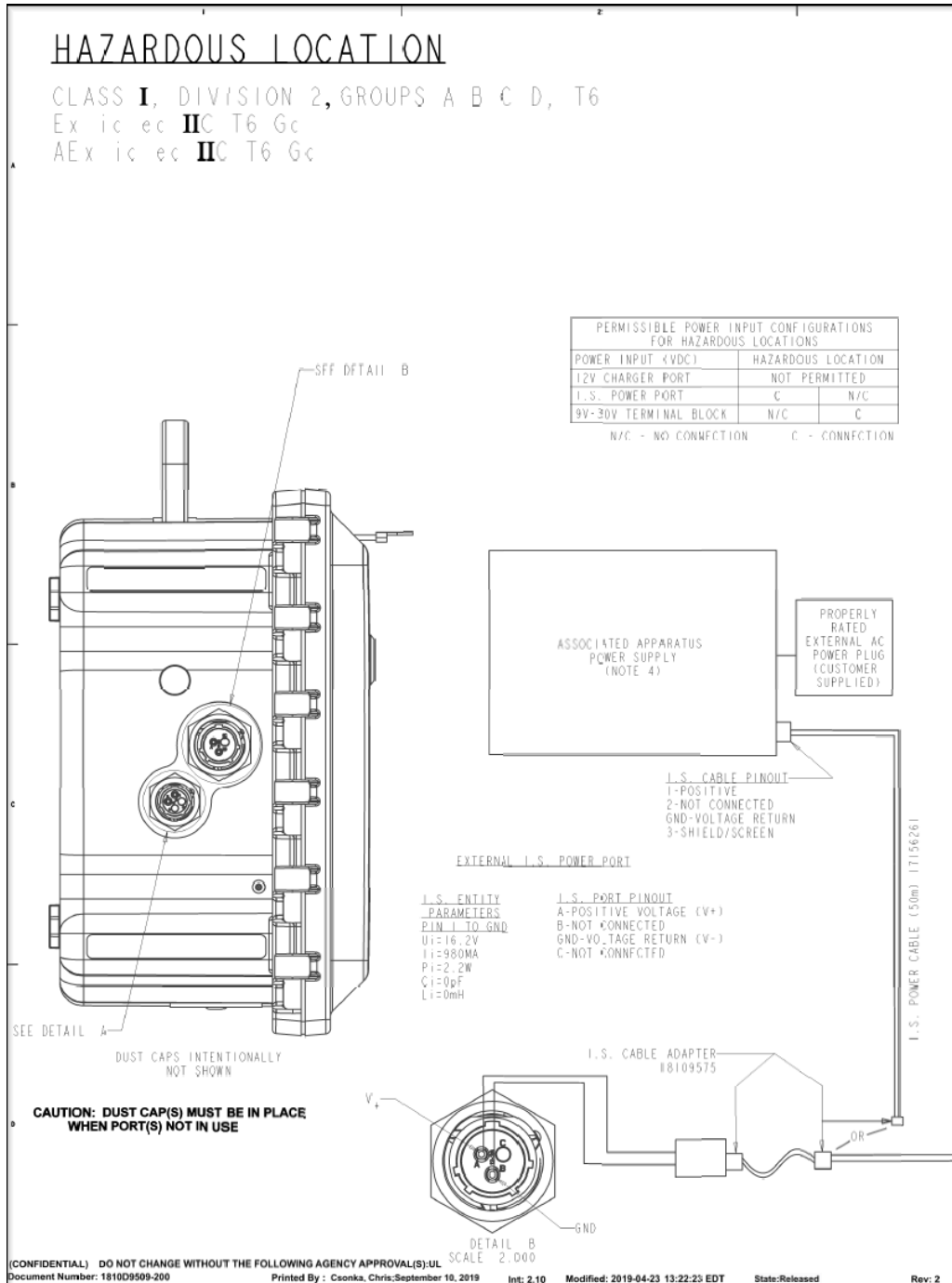

From Figure A.1.B

Figure A.1.A Control drawing 1810D9509-200

# NON-HAZARDOUS LOCATION

WARNING: CONNECT AND USE THE CHARGING PORT IN NON-HAZARDOUS AREAS, ONLY

THE INTRINSICALLY SAFE POWER PORT CAN BE CONNECTED TO THE I.S. EXTENDED RUNTIME POWER SUPPLY AND THE EXTENDED RUNTIME POWER SUPPLY IN HAZARDOUS AREAS.

ONLY ONE(1) POWER INPUT IS PERMITTED TO BE CONNECTED AT ANY TIME.

| PERMISSIBLE POWER INPUT CONFIGURATIONS FOR NON-HAZARDOUS LOCATIONS |                        |     |     |
|--|------------------------|-----|-----|
| POWER INPUT (VDC)  | NON-HAZARDOUS LOCATION |     |     |
| 12V CHARGER PORT   | C                      | N/C | N/C |
| I.S. POWER PORT  | N/C                    | C   | N/C |
| 9V-30V TERMINAL BLOCK  | N/C                    | N/C | C   |

N/C - NO CONNECTION C - CONNECTION

## NOTES:

1. FOR ENTITY CONCEPT USE THE APPROPRIATE PARAMETERS TO ENSURE THE FOLLOWING CONDITIONS:

$$V_o(\text{or } U_o) \leq V_{MAX}(\text{or } U_i)$$

$$I_s(\text{or } I_o) \leq I_{MAX}(\text{or } I_i)$$

$$P_o \leq P_i$$

$$C_a(\text{ or } C_o) \leq C_i + C_{CABLE}$$

$$L_a(\text{ or } L_o) \leq L_i + L_{CABLE}$$

2. ASSOCIATED APPARATUS SHALL BE INSTALLED PER MANUFACTURERS INSTALLATION INSTRUCTIONS. THE WIRING OF INTRINSICALLY CIRCUITS MUST BE INSTALLED PER NATIONAL AND/OR LOCAL CODES, STANDARDS AND REGULATIONS. (E.G. NEC ARTICLE 504, CEC SECTION 18, IEC/EN 60079-14).

3. ALL BATTERIES ARE TO BE INSTALLED IN A NON-HAZARDOUS AREA BY TRAINED PERSONEL, ONLY.

4. ASSOCIATED APPARATUS MAY BE INSTALLED IN A DIVISION 2 OR ZONE 2 LOCATION IF SO APPROVED.

5. CONTROL EQUIPMENT MUST NOT USE OR GENERATE MORE THAN  $U_m$  VALUE OF ASSOCIATED APPARATUS.

6. WHERE THE CABLE CAPACITANCE AND INDUCTANCE PER METER ARE NOT KNOWN, THE FOLLOWING VALUES SHALL BE USED:  
 $C_{CABLE} = 197.2\text{pF/m}$ ,  $L_{CABLE} = 0.656\text{uH/m}$

7. CUSTOMER TO REMOVE CONDUIT HUB PLUG AND INSTALL DEVICE TO CONDUIT PER NATIONAL AND/OR LOCAL CODES, STANDARDS AND REGULATIONS.

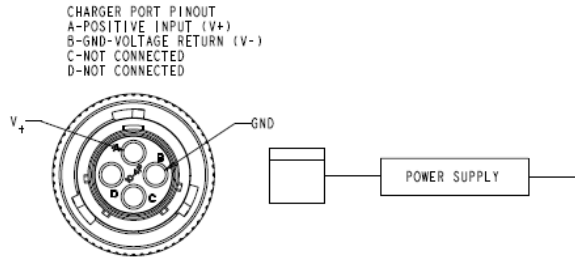
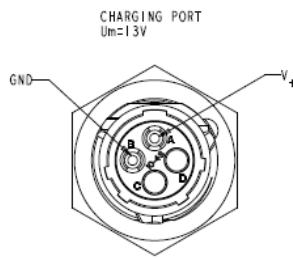

DETAIL A  
SCALE 3.000

I.S. CABLE PINOUT  
 1-POSITIVE  
 2-NOT CONNECTED  
 GND-VOLTAGE RETURN  
 3-SHIELD/SCREEN

TYPICAL ISC POWER CABLE PARAMETERS:  
 $C_{CABLE} = 0.16\text{nF/m}$   
 $L_{CABLE} = 750\text{nH/m}$   
 $R_{CABLE} = 22\text{m}\Omega/\text{m}$

I.S. POWER CABLE, (50m): 17156261

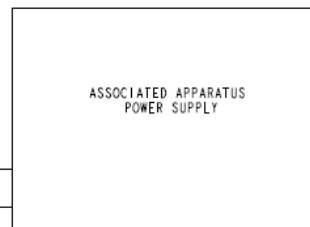

To  
Figure  
A.1.A

|   |   |
|---|---|
| <p>INDUSTRIAL SCIENTIFIC CORPORATION</p> <p>TITLE: CONT. INST. BOX GATEWAY CONTROL DRAWING</p>  |   |
| <p>REVISIONS DIMENSIONS AND/OR SPECIFICATIONS WHICH WERE CHANGED FOR THIS REVISION SHALL BE IDENTIFIED BY A NUMBER, DATE AND BY WHOM IN THE REVISION HISTORY.</p>                   | <p>NO. REV. SCALE</p> <p>DATE</p>   |
| <p>TOLERANCE UNLESS OTHERWISE SPECIFIED</p> <p>FRACTIONS: 1/16, 1/8, 3/16, 1/4, 3/8, 1/2, 5/8, 3/4, 7/8</p> <p>DECIMALS: 0.005, 0.01, 0.02, 0.05, 0.1, 0.15, 0.2, 0.3, 0.5, 1.0</p> | <p>ENGINEER: W. WELSHBY</p> <p>DRAWING NUMBER: 1810D9509-200</p> <p>1 2 2</p> <p>SCALE: 1:100</p> <p>DRAWN BY: W. WELSHBY</p> <p>CHECKED BY: W. WELSHBY</p> |

Figure A.1.B Control drawing 1810D9509-200

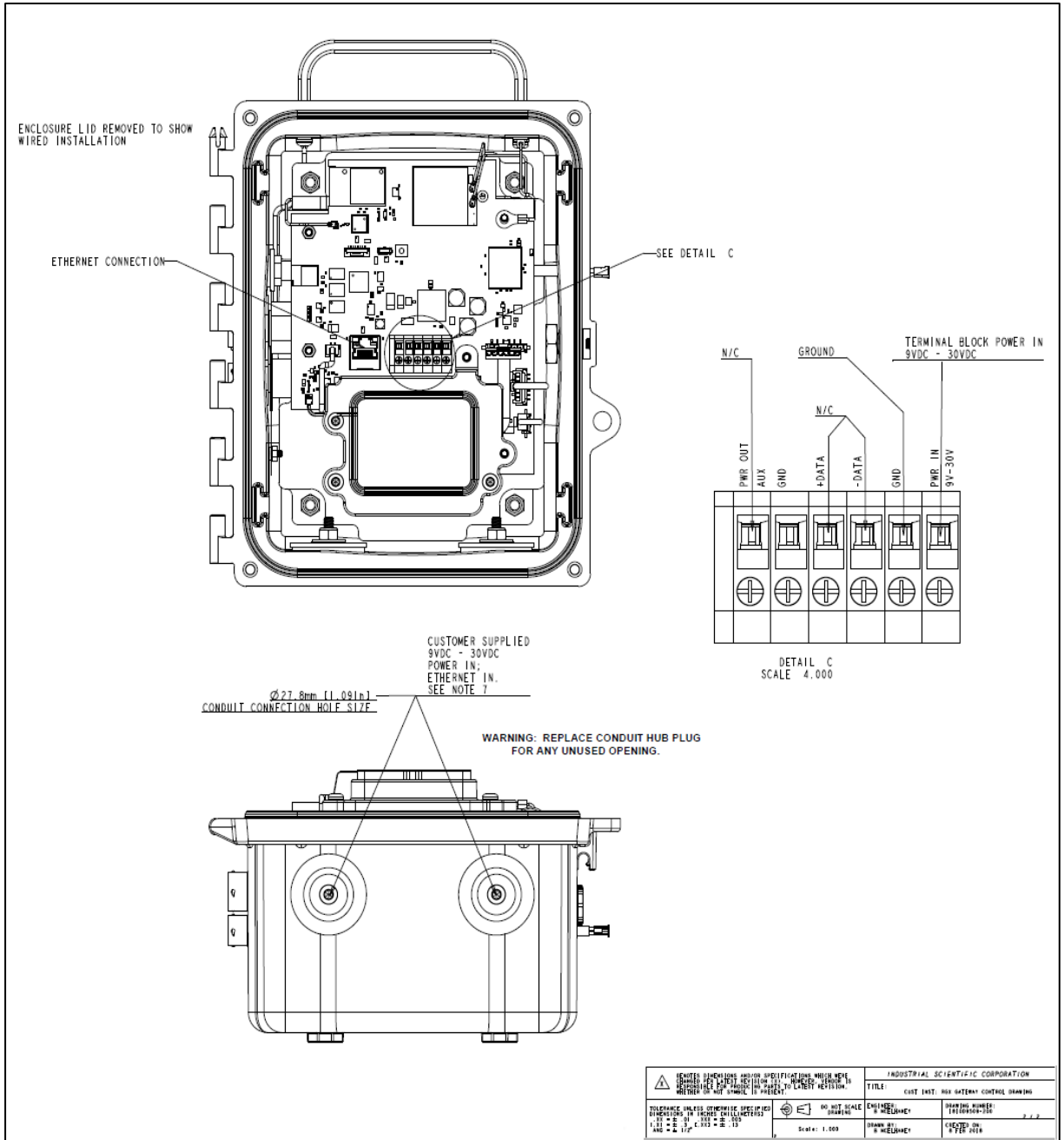

Figure A.1.C Control drawing 1810D9509-200, Internal electrical connections



# Appendix C

## Applicable Certification Standards

- UL 121201; Nonincendive Electrical Equipment for Use in Class I and II, Division 2 and Class III, Divisions 1 and 2 Hazardous (Classified) Locations; 9<sup>th</sup> Ed.
- UL 61010-1; Electrical Equipment for Measurement, Control, and Laboratory Use; Part 1: General Requirements - 2<sup>nd</sup> Ed.; 2013/07/12
- UL 61010-2-201; UL Standard for Safety Requirements for Electrical Equipment for Measurement, Control, and Laboratory Use - Part 2-201: Particular Requirements for Control Equipment – Ed. 1; 2017/02/20
- CSA C22.2 No. 213-17; Nonincendive Electrical Equipment for Use in Class I and II, Division 2 and Class III, Divisions 1 and 2 Hazardous (Classified) Locations
- CSA 22.2 No. 61010-1-12; Electrical Equipment for Measurement, Control, and Laboratory Use; Part 1: General Requirements – 3rd Ed.
- CSA 22.2 No. 61010-2-201:14; Electrical Equipment for Measurement, Control, and Laboratory Use; Part 2-201: Particular Requirements for Control Equipment: 1<sup>st</sup> Ed.
- UL 2054; Standard for Household and Commercial Batteries; 2011/09/14
- IEC 60079-0:2017; Explosive atmospheres Part 0 - Equipment - General requirements
- IEC 60079-7:2017; Explosive atmospheres Part 7 - Equipment protection by increased safety 'e'
- IEC 60079-11:2011; Explosive atmospheres Part 11 - Equipment protection by intrinsic safety 'i'
- EN 60079-0:2018; Explosive atmospheres Part 0 - Equipment - General requirements
- EN 60079-7:2015 + A1:2018; Explosive atmospheres Part 7 - Equipment protection by increased safety 'e'
- EN 60079-11:2012; Explosive atmospheres Part 11 - Equipment protection by intrinsic safety 'i'
- UL 60079-0 - Explosive Atmospheres – Part 0: Equipment – General Requirements
- UL 60079-7 - Explosive Atmospheres- Part 7: Equipment Protection by Increased Safety "e"
- UL 60079-11 - Explosive Atmospheres - Part 11: Equipment Protection by Intrinsic Safety "i"
- CSA C22.2 No. 60079-0:19 Explosive atmospheres - Part 0: Equipment - General requirements
- CSA C22.2 No. 60079-7:16 Explosive atmospheres - Part 7: Equipment protection by increased safety "e"
- CSA C22.2 No. 60079-11:14 Explosive atmospheres - Part 11: Equipment protection by intrinsic safety "i"
- GB3836.1-2010; Explosive atmospheres Part 1 - Equipment - General requirements
- GB3836.3-2010; Explosive atmospheres Part 3 - Equipment protection by increased safety 'e'
- GB3836.4-2010; Explosive atmospheres Part 4 - Equipment protection by intrinsic safety 'i'
- ABNT NBR IEC 60079-0:2013 Explosive atmospheres - Part 0: Equipment- General requirements.
- ABNT NBR IEC 60079-7:2008 Explosive atmospheres - Part 7: Equipment protection by increased safety.
- ABNT NBR IEC 60079-11:2013 Explosive atmospheres - Part 11: Equipment protection by intrinsic safety "i".
- GB3836.13-2013: Explosive atmospheres Part 13 – Equipment repair, overhaul and reclamation
- GB3836.15-2017: Explosive atmospheres Part 15 – Electrical installations design, selection and erection
- GB3836.16-2017: Explosive atmospheres Part 16- Electrical installations inspection and maintenance
- GB3836.18-2017: Explosive atmospheres Part 18 – Intrinsically safe electrical systems
- GB50527-2014: Code for construction and acceptance of electric equipment on fire and explosion hazard electrical equipment installation engineering

# Contact Information

## Industrial Scientific Corporation

1 Life Way  
Pittsburgh, PA 15205-7500 USA  
Web: [www.indsci.com](http://www.indsci.com)  
Phone: +1 412-788-4353 or 1-800-DETECTS (338-3287)  
E-mail: [info@indsci.com](mailto:info@indsci.com)  
Fax: +1 412-788-8353

## Industrial Scientific France S.A.S.

11D Rue Willy Brandt  
62002 Arras Cedex, France  
Web: [www.indsci.com](http://www.indsci.com)  
Téléphone : +33 (0)1 57 32 92 61  
E-mail: [info@eu.indsci.com](mailto:info@eu.indsci.com)  
Fax: +33 (0)1 57 32 92 67

## 英思科传感仪器（上海）有限公司

地址：中国(上海)自由贸易试验区桂桥路 290 号  
邮编：201206  
电话：+86 21 5899 3279  
传真：+86 21 5899 3280  
E-mail： [iscapinfogroup@indsci.com](mailto:iscapinfogroup@indsci.com)  
网址： [www.indsci.com](http://www.indsci.com)  
服务热线：+86 400 820 2515

To locate a nearby distributor of our products or an Industrial Scientific service center or business office, visit us at [www.indsci.com](http://www.indsci.com).

Rendez-vous sur notre site Web [www.indsci.com](http://www.indsci.com), si vous voulez trouver un distributeur de nos produits près de chez vous, ou, si vous recherchez un centre de service ou un bureau Industrial Scientific.

Besuchen Sie uns unter [www.indsci.com](http://www.indsci.com), um einen Vertriebshändler unserer Produkte oder ein Servicecenter bzw. eine Niederlassung von Industrial Scientific zu finden.

Para buscar un distribuidor local de nuestros productos o un centro de servicio u oficina comercial de Industrial Scientific, visite [www.indsci.com](http://www.indsci.com).

如需查找就近的产品经销商或 Industrial Scientific 服务中心或业务办事处，请访问我们的网站 [www.indsci.com](http://www.indsci.com)

**INDUSTRIAL**  

---

**SCIENTIFIC**